



Province of the  
**EASTERN CAPE**  
EDUCATION

**NATIONAL  
SENIOR CERTIFICATE**

**GRADE 11**

**NOVEMBER 2020**

**ELECTRICAL TECHNOLOGY: DIGITAL  
ELECTRONICS  
MARKING GUIDELINE  
(EXEMPLAR)**

**MARKS: 200**

---

This marking guideline consists of 13 pages.

---

**INSTRUCTIONS TO MARKERS**

1. All questions with multiple answers imply that any relevant, acceptable answer should be considered.
2. Calculations:
  - 2.1 All calculations must show the formulae.
  - 2.2 Substitution of values must be done correctly.
  - 2.3 All answers **MUST** contain the correct unit to be considered.
  - 2.4 Alternative methods must be considered, provided that the correct answer is obtained.
  - 2.5 Where an incorrect answer could be carried over to the next step, the first answer will be deemed incorrect. However, should the incorrect answer be carried over correctly, the marker has to re-calculate the values using the incorrect answer from the first calculation. If correctly used, the candidate should receive the full marks for subsequent calculations.
  - 2.6 Markers should consider that candidates' answers may deviate slightly from the marking guideline depending on how and where in the calculation rounding off was used.
3. These marking guidelines are only a guide with model answers.
4. Alternative interpretations must be considered and marked on merit. However, this principle should be applied consistently throughout the marking session.

**QUESTION 1: OCCUPATIONAL HEALTH AND SAFETY**

- 1.1 Where the operating voltage does not exceed 50 V. ✓  
Roofs, gutters, downpipes, and wastepipes made of non-conductive material.  
On premises which receive electricity by means of underground service connections. ✓  
All metallic parts that are not part of the electrical circuit, that can become live, but have an insulated covering. (2)
- 1.2 1.2.1 Lack of space can lead to chances of mistakes or even injury. ✓ (1)
- 1.2.2 Incorrect lighting can lead to eye strain. ✓ (1)
- 1.3 It is the study of the human body ✓ and its movement. ✓ (2)
- [6]**

**QUESTION 2: TOOLS AND MEASURING INSTRUMENTS**

- 2.1 A crimping lug offers a quick and permanent solution of terminating a cable. ✓ (1)
- 2.2 The clamp meter is safer and easier to use, ✓ because there is no need to connect to the circuit to make measurements. ✓ (2)
- 2.3 This is the time the bonding of the wheel is liable to disengage and break apart. ✓ Therefore, it is not safe to be standing in the direct path of any pieces that may be thrown out by centrifugal force. ✓ (2)
- 2.4 The time base generator generates the internal saw tooth waveform to control the horizontal sweep of the trace. ✓ (1)
- [6]**

**QUESTION 3: LOGICS**

3.1 3.1.1 OR gate ✓ (1)

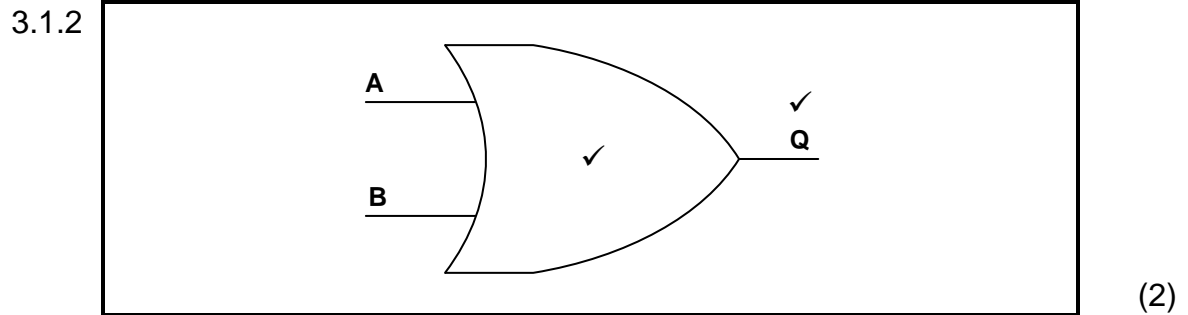

3.1.3

S1	S2	Output (Q)
0	0	0 ✓
0	1	1 ✓
1	0	1 ✓
1	1	1 ✓

(4)

3.1.4  $Q=A+B$  ✓✓ (2)

3.2  $X = \bar{A}\bar{B}\bar{C} + A\bar{B}\bar{C} + A\bar{B}C + A\bar{B}C$

$$= (\bar{A}\bar{B}\bar{C} + A\bar{B}\bar{C}) + (A\bar{B}C + A\bar{B}C)$$

$$= \bar{B}\bar{C}(A + \bar{A}) + \bar{B}C(A + \bar{A})$$

$$= \bar{B}\bar{C} + \bar{B}C$$

$$= \bar{C}(\bar{B} + B)$$

$$= \bar{C}$$

(7)

3.3

C ✓	AB ✓			
	00	01	11	10
0	1 ✓	1 ✓	1 ✓	1 ✓
1 ✓				

(7)

3.4 Logic high ✓  
Logic low ✓ (2)

3.5 Simple, compatible with CMOS if the applied voltage is the same, can be constructed using discrete components. ✓  
They have a low current drain. ✓ (2)

3.6 Slow switching speed ✓  
They can be easily destroyed by static electricity ✓ (2)

3.7 3.7.1  $Q1 \checkmark = A.B \checkmark$  (2)

3.7.2  $Q2 = A \checkmark .C \checkmark$  (2)

3.7.3  $Q = (A.B) \checkmark + \checkmark (A.C) \checkmark$  (3)

3.8

Inputs		Outputs	
A	B	Sum	Carry
0	0	0	0 ✓
0	1	1	0 ✓
1	0	1	0 ✓
1	1	0	1 ✓

(4)

[40]

**QUESTION 4: COMMUNICATION SYSTEMS**

4.1 Resonance is the increase in amplitude of an oscillation in mechanical or electrical systems, ✓ under the influence of an external periodic impulse of similar frequency to the original vibration. ✓ (2)

4.2

- The basic LC resonant oscillator ✓
- Hartley oscillator ✓
- Colpitts oscillator ✓
- The RC phase shift oscillator
- The Wien bridge oscillator

(3)

4.3 The Wien bridge oscillator is among the simplest sine wave oscillators which uses an RC network, ✓ rather than a tuned LC tank circuit. ✓ It is based on the frequency selective form of a wheatstone bridge circuit. ✓ It uses feedback from two RC circuits, a series RC circuit connected with a parallel RC which together are very frequency selective. ✓ They combine to cause a phase shift of exactly  $0^\circ$  for only the chosen resonant frequencies' ✓ while all higher or lower frequencies are shifted in phase resulting in them not being able to drive the circuit into oscillation. ✓ (6)

4.4 A variable frequency oscillator is an oscillator circuit which has one of its oscillating components that is adjustable. ✓ It is a widely used component in all tunable radio receivers and transmitters ✓ that work using the superheterodyne principle. ✓ (3)

4.5

- Correction of radio controlled communication ✓
- Radio control ✓

(2)

4.6 Modulation refers to the changing of high frequency signal ✓ in a way that is able to carry information ✓ (2)

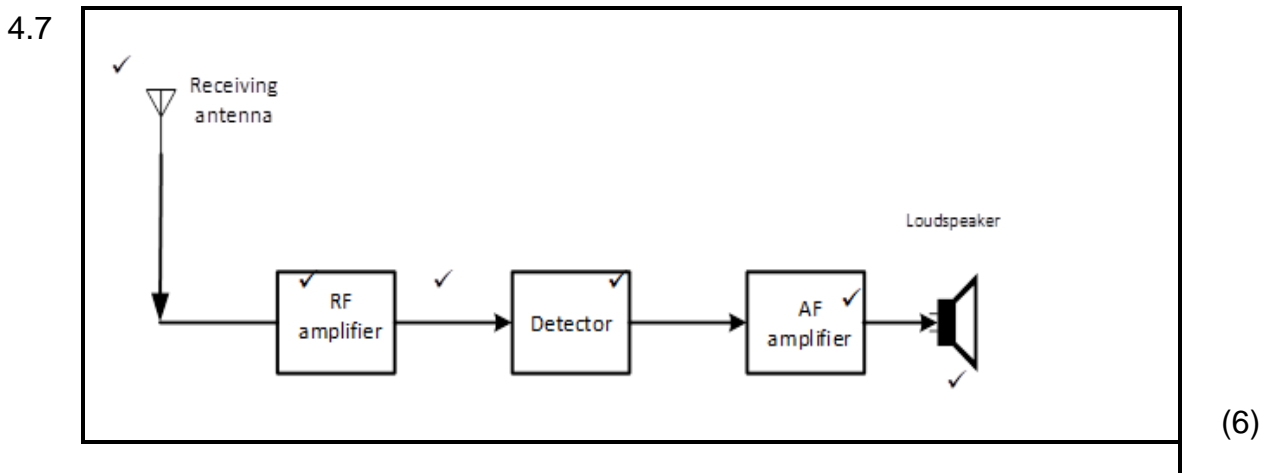

4.8 Frequency-shift keying is a method of being able to transmit a digital pulse signal ✓ using traditional radio transmitting and receiving methods. ✓ (2)

**[26]**

QUESTION 5: RLC-CIRCUITS

5.1 The capacitance of the capacitor ✓  
The frequency of the supply (1)

5.2

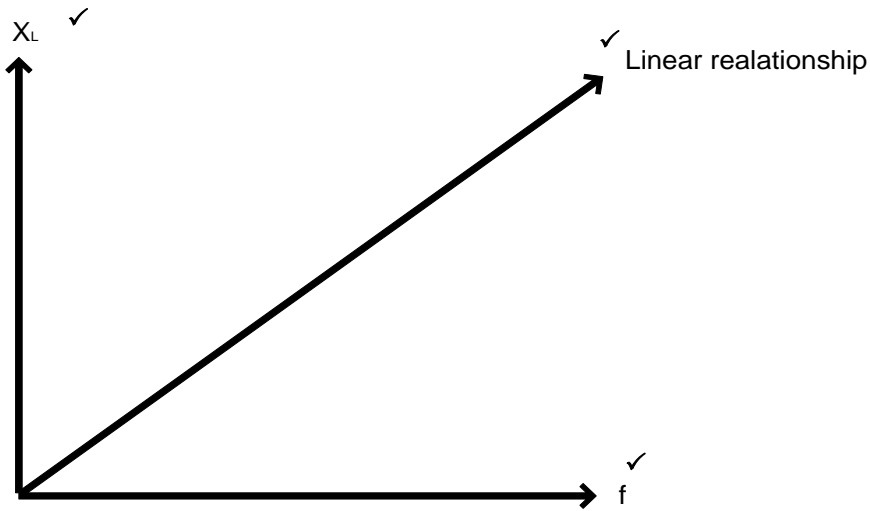

(3)

5.3 5.3.1 The current lags the voltage by 90 degrees. ✓ (1)

5.3.2 An increase in frequency causes the inductive reactance to increase. ✓ This will cause the impedance to increase ✓ and the maximum value of the current waveform to decrease. ✓ (3)

5.4 5.4.1  $X_L = 2\pi fL$  ✓  
 $= 2 \times \pi \times 50 \times 0,159$  ✓  
 $= 49,95\Omega$  ✓ (3)

5.4.2  $Z = \sqrt{R^2 + (X_L - X_C)^2}$  ✓  
 $= \sqrt{33^2 + (49,95 - 31,83)^2}$  ✓  
 $= 37,65\Omega$  ✓ (3)

5.4.3  $I = \frac{V}{Z}$  ✓  
 $= \frac{100}{37,65}$  ✓  
 $= 2,66A$  ✓ (3)

5.4.4  $X_C = \frac{1}{2\pi fC}$   
 $C = \frac{1}{2\pi fX_C}$  ✓  
 $= \frac{1}{2 \times \pi \times 50 \times 31,83}$  ✓  
 $= 1 \times 10^{-4}F = 100 \mu F$  ✓ (3)

5.5 At the resonant frequency point the two reactance are identical in size ✓ but exactly opposite to each other in direction making  $X_L - X_C = 0$  or  $X_L = X_C$ . ✓ At this point they cancel each other's effect and the only resistance left in the circuit is the resistance of the resistor R ✓ where the component impedance will be equal to resistance. ✓ (4)

[24]

**QUESTION 6: WAVEFORMS**

- 6.1 6.1.1 Saw tooth wave ✓ (1)
- 6.1.2 Square wave ✓ (1)
- 6.1.3 Sine wave ✓ (1)
- 6.1.4 Audio wave ✓ (1)
- 6.2 The period is the time taken ✓ to complete one ✓ full cycle. ✓ (3)
- 6.3.1 This is the time between the 50% ✓ amplitude points on both the rising ✓ and the falling edges of the pulse. ✓ (3)
- 6.3.2 Fall time, this is the time a falling pulse takes to make a change from the higher state 'on' ✓ to the lower state 'off'. ✓ It is measured between the 10% and 90% points of the completed pulse. ✓ (3)
- 6.4  $V_{rms} = V_{pk} \times 0,707 V$   
 $V_{pk} = \frac{V_{rms}}{0,707} V \checkmark$   
 $= \frac{9}{0,707} V \checkmark$   
 $= 12,73 V \checkmark$  (3)
- 6.5  $T = \frac{1}{f} s \checkmark$   
 $= \frac{1}{500} s \checkmark$   
 $= 0,002 \text{ sec or } 2 \text{ ms} \checkmark$  (3)
- 6.6 The clamping circuit actually binds the upper or lower ✓ extremes of a waveform to a fixed DC voltage level. ✓ When unbiased, clamping circuits will fix ✓ the voltage lower limit ✓ (or upper limit, in the case of negative clampers) to 0 volt. (4)
- 6.7
  - Communication ✓
  - Broadcasting ✓
  - Computer network ✓
(3)

**[26]**



## QUESTION 7: POWER SUPPLIES

7.1

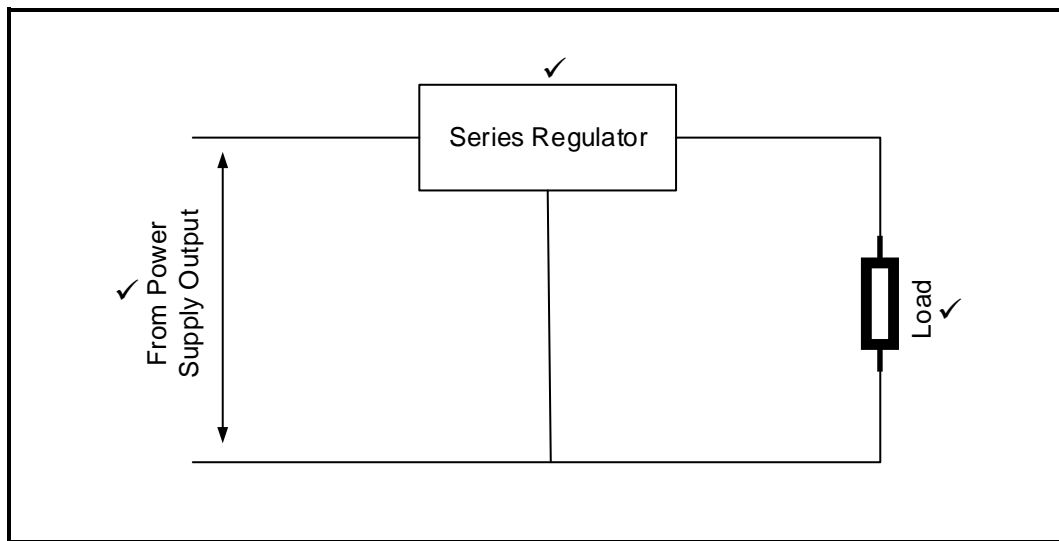

(3)

7.2 7.2.1  $P_Z = V_Z \times I_Z$

$$I_Z = \frac{P_Z}{V_Z} \text{ A } \checkmark$$

$$= \frac{2}{5} \text{ A } \checkmark$$

$$= 400 \text{ mA } \checkmark$$

(3)

7.2.2  $R_S = \frac{V_S - V_Z}{I_Z} \Omega \checkmark$

$$= \frac{12 - 5}{0,4} \Omega \checkmark$$

$$= 17,5 \Omega \checkmark$$

(3)

7.2.3  $I_L = \frac{V_Z}{R_L} \text{ A } \checkmark$

$$= \frac{5}{1000} \text{ A } \checkmark$$

$$= 5 \text{ mA } \checkmark$$

(3)

**[12]**

**QUESTION 8: SEMI-CONDUCTOR DEVICES**

8.1 A semiconductor is a material of which the conductivity ✓ lies between that of a conductor ✓ and an insulator. ✓  
Semiconductor devices are electronic components that are made from materials like silicon that have four valence electrons and their conduction can be controlled. (3)

8.2 It is the point of intersection ✓ between the diode's characteristic ✓ and the circuit's load line. ✓ (3)

8.3 The majority carriers in P-type silicon are holes ✓ formed when adding impurities. ✓ (2)

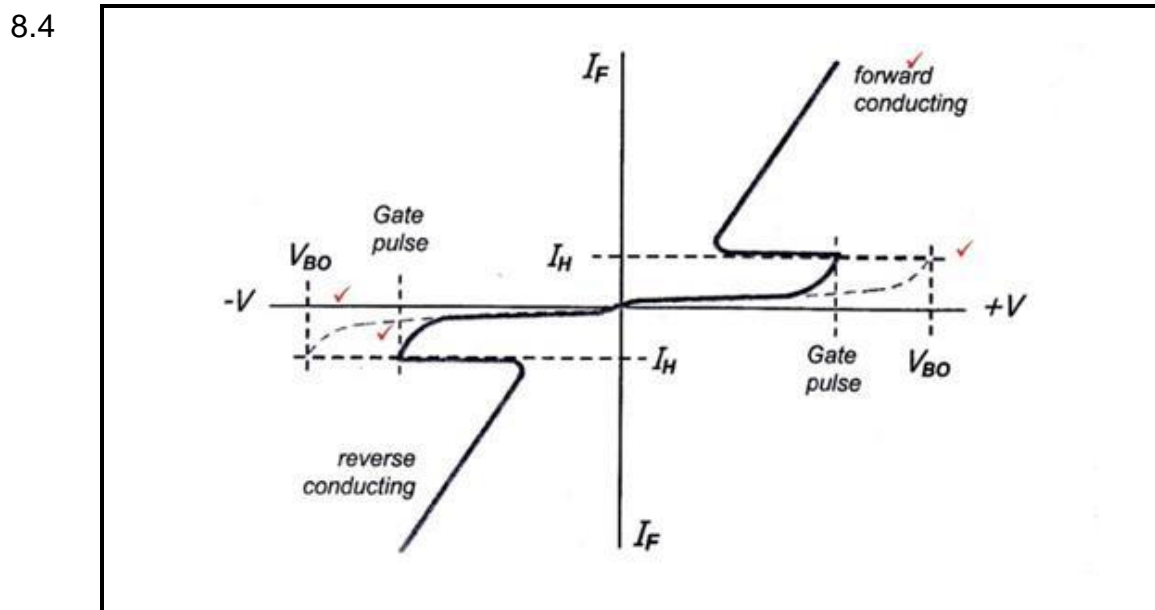

8.5.1 • Internet ✓  
• Manufacturers' technical support material (1)

8.5.2 Semiconductors are very sensitive to temperature. ✓ It is crucial to know the operating temperature of the device, ✓ so that it is not destroyed or its operating conditions changed. ✓ (3)

8.5.3 • Electrical characteristics ✓  
• Equivalent values ✓ (2)

8.6.1

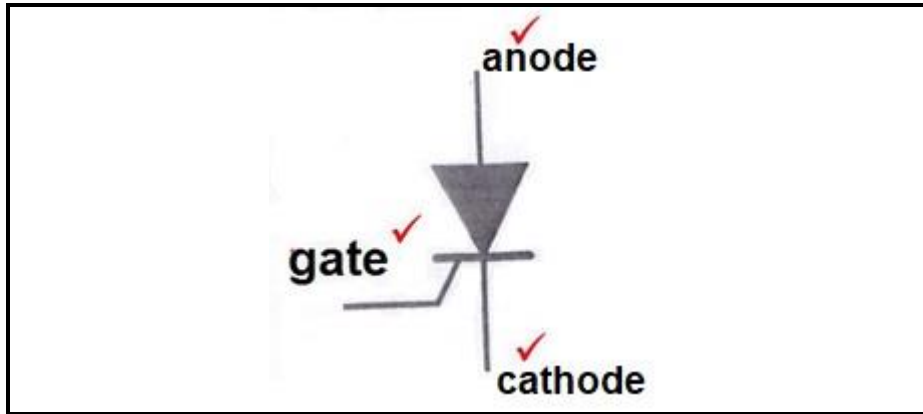

(3)

8.6.2

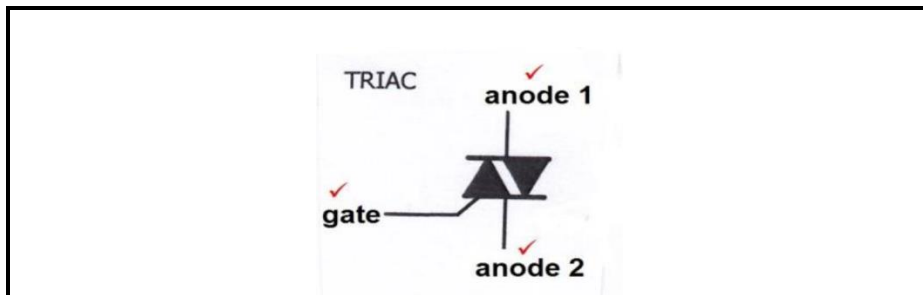

(3)

8.7 Electron flow is the movement of electrons ✓ through material, from a negative potential to a positive potential. ✓  
Conventional current flow is the flow of current ✓ from a positive potential to a negative potential. ✓ (4)

8.8 Solid-state devices are devices that are built entirely from solid materials ✓ and in which the electrons or other charge carriers are confined entirely within the solid material. ✓ (2)

8.9 N-type material is formed when a semiconductor (silicon), which has four valence electrons, ✓ is doped with a material that has five valence electrons. ✓  
Four valence electrons from the semiconductor and from the impurity combine and form covalent bonds. ✓  
The fifth electron remains unbonded. ✓  
This creates an excess of electrons that can be broken away from their atoms and become part of conduction. ✓ (5)

8.10 A zener diode has a unique reverse biased operating characteristic ✓ in that it blocks any flow of current when under low reverse voltage ✓ but as soon as the voltage rises to reach its 'zener breakdown', it breaks down and allows a current to flow in the reverse direction without any damage to itself. ✓ (3)

8.11.1 Emitter ✓ base ✓ – junction needs to be forward biased. (2)

8.11.2 Collector ✓ base ✓ – junction should be reverse biased. (2)

8.12 The usual method of turning an SCR on is by forward biasing the anode-cathode ✓ terminals and applying a positive voltage to the gate terminal, ✓ by raising the anode-cathode forward biasing voltage ✓ to a large positive level which will force the one reverse biased PN junction to break down. ✓ (4)

8.13

- Boron ✓
- Gallium ✓
- Indium

(2)  
**[48]**

**QUESTION 9: SENSORS AND TRANSDUCERS**

- 9.1 A sensor is a device that detects or senses an 'input-function', reacts to it and executes it. ✓ It also involves measuring physical quantities. ✓ (2)
- 9.2 The dynamic microphone has a small movable induction coil attached to a diaphragm placed in a magnetic field created by a permanent magnet. ✓ The sound waves from a voice create air pressure variations that make the diaphragm vibrate. ✓ The vibrating diaphragm attached to the coil produces an induced varying current. ✓ In this way sound energy will be converted to electrical energy. ✓ (4)
- 9.3
- Capacitive humidity sensor ✓
  - Resistive humidity sensor ✓
  - Thermal conductivity sensor
- (2)
- 9.4 If the light on the surface of the LDR increases, ✓ the resistance will decrease. ✓ If the light on the surface of the LDR decreases, ✓ the resistance will increase. ✓ (4)

**[12]****TOTAL: 200**