

Ons leer van die Grondwet van die Republiek van Suid-Afrika (1996)

Die Grondwet van Suid-Afrika (1996) is die hoogste wet in die land. Hierdie wet is hoër as die President, hoër as die houe en hoër as die regering.

Die Grondwet beskryf hoe die mense van die land mekaar moet behandel, wat hulle regte is en wat hulle verantwoordelikhede teenoor mekaar is. Die Grondwet is daar om ons almal vandag te beskerm en om die kinders van die toekoms te beskerm.

Onthou ons verlede.

Ons moenie die foute van die verlede herhaal nie.

Ons Grondwet help ons om 'n beter toekoms vir almal te beplan en te bou.

Ons, die mense van Suid-Afrika,
Erken die ongeregtighede van ons verlede;
Huldig diegene wat vir geregtigheid en vryheid in ons land gelyk het;
Respekteer diegene wat hul beywer het om ons land op te bou en te ontwikkel; en
Glo dat Suid-Afrika behoort aan almal wat daarin woon, verenig in ons verskeidenheid.
Daarom neem ons, deur ons vryverkose verteenwoordigers, hierdie Grondwet aan as die hoogste reg van die Republiek ten einde—



Die verdeeldheid van die verlede te heel en 'n samelewing gegrond op demokratiese waardes, maatskaplike geregtigheid en basiese menseregte te skep;
Die grondslag te lê vir 'n demokratiese en oop samelewing waarin regering gegrondves is op die wil van die bevolking en elke burger gelyk deur die reg beskerm word;
Die lewensgehalte van alle burgers te verhoog en die potensiaal van elke mens te ontsluit; en

'n Verenigde en demokratiese Suid-Afrika te bou wat sy regmatige plek as 'n soewereine staat in die gemeenskap van nasies kan inneem.

Maak aanspraak op jou regte as 'n Suid-Afrikaner en beskerm die regte van andere.

Maak seker dat jy die Handves van Regte en Verantwoordelikhede ken.

Mag God ons mense beskerm.

Nkosi Sikelel' iAfrika. Morena boloka setjhaba sa heso.

God seën Suid-Afrika. God bless South Africa.

Mudzimu fhatutshedza Afurika. Hosi katekisa Afrika.



**MATHEMATICS IN AFRIKAANS
GRADE 1 – BOOK 1**

TERMS 1 & 2

ISBN 978-1-920458-83-6

THIS BOOK MAY NOT BE SOLD.

11th Edition



9 781920 458836



WISKUNDE IN AFRIKAANS – Graad 1 Boek 1

ISBN 978-1-920458-83-6

Hersien volgens die KABV



Naam:

Klas:



basic education

Department:
Basic Education
REPUBLIC OF SOUTH AFRICA

WISKUNDE IN AFRIKAANS

Boek 1
Kwartaal
1 & 2



Inhoud

No.	Titel	Bl.
1	Hersiening: Opsporing en pas	2
2	Hersiening: Sorteër kleure en trek patrone na	4
3	Hersiening: Kleure en patrone	6
4	Hersiening: Sorteër en pas vorms	8
5	Hersiening: Soek en tel	10
6	Hersiening: Posisies	12
7	Hersiening: Tyd	14
8	Hersiening: Vorms, groottes en kleure	16
9	Een	18
10	Twee	20
11	Drie	22
12a	Lengte en posisie	24
12b	Lengte	26
13	Vergelyk getal 1-3	28
14	Vier	30
15	Tel by en trek af tot by 4	32
16	Tyd	34
17	Vyf	36
18	Hersien getalle 1 tot 5	38
19	Tel op tot by 5	40
20	Trek af van 5 en tel tot by 5	42
21	Tel op en trek af tot by 5	44
22	Optelling en aftrekking 1 tot 5	46
23	Balle en blokkies	48
24a	Links en regs	50
24b	Rigting	52
25	Die opbou en afbreek van getalle	54
26	Verdubbeling	56
27	Groter en kleiner	58
28	Sorteer voorwerpe	60
29	Kom ons verdeel gelykop	62
30	Gelyke verdeling	64
31	Bou met voorwerpe	66
32	Lees hoe laat dit is	68

No.	Titel	Bl.
33	Ses	70
34	Sewe	72
35	Agt	74
36	Nege	76
37	Vol en leeg	78
38	Tien	80
39	Nommer van 1 tot 10	82
40	Inhoudsmaat en volume	84
41	Getalle van 1 tot 10	86
42	Meer, net soveel en minder	88
43	Tel die lekkers op	90
44	Versamel en organiseer	92
45	Optelling tot by 10: tel aan	94
46	Optelling: bou en breek af tot by 10	96
47	Verdubbeling en halvering	98
48a	Vorms	100
48b	Nog 2-D vorms	102
49	Groepe van twee tot 10	104
50	Herhaalde optelling van twees tot by 10	106
51	Patrone: 2 tot 20	108
52	Groepe van drie tot by 10	110
53	Herhaalde optelling van drieë tot by 10	112
54	Groepe van vier tot by 10	114
55	Herhaalde optelling van viere tot by 10	116
56	Groepe van vyf tot by 10	118
57	Herhaalde optelling van vywe tot by 10	120
58	Patrone: 5 tot 20	122
59	Patrone: Tiene	124
60a	Geld	126
60b	Geld (vervolg)	128
61	Geld en kleingeld	130
62	Nog geld en kleingeld	132
63	Vorm, oriëntasie en posisie	134
64a	Patrone met meetkundige vorms	136
64b	2D-vorms en 3D-voorwerpe	138



Mev. Angie Motshekga,
Minister van Basiese
Onderwys



Dr. Reginah Mhaule,
Adjunkminister van Basiese
Onderwys

Hierdie Werkboeke is vir Suid-Afrika se kinders ontwikkel onder leiding van die Minister van Basiese Onderwys, mev. Angie Motshekga, en die Adjunkminister van Basiese Onderwys, dr. Reginah Mhaule.

Die Reënboog-Werkboeke maak deel uit van 'n reeks intervensies deur die Departement van Basiese Onderwys met die doel om die prestasie van Suid-Afrikaanse leerders in die eerste ses grade te verbeter. Hierdie projek is 'n prioriteit van die Regering se Plan van Aksie en is moontlik gemaak deur die ruim befondsing van die Nasionale Tesourie. Die Departement is hierdeur in staat gestel om hierdie Werkboeke gratis in al die amptelike tale te voorsien.

Ons hoop dat u as onderwyser hierdie Werkboeke in u daaglikse onderrig nuttig sal vind en ook sal verseker dat u leerders die kurrikulum dek.

Al die aktiwiteite in die Werkboeke het ikone om aan te dui wat die leerders moet doen.

Ons hoop van harte dat leerders dit gaan geniet om die boeke deur te werk terwyl hulle leer en groei, en dat u as onderwyser dit saam met hulle sal geniet.

Ons wens u en u leerders alle sukses in die gebruik van hierdie Werkboeke toe.

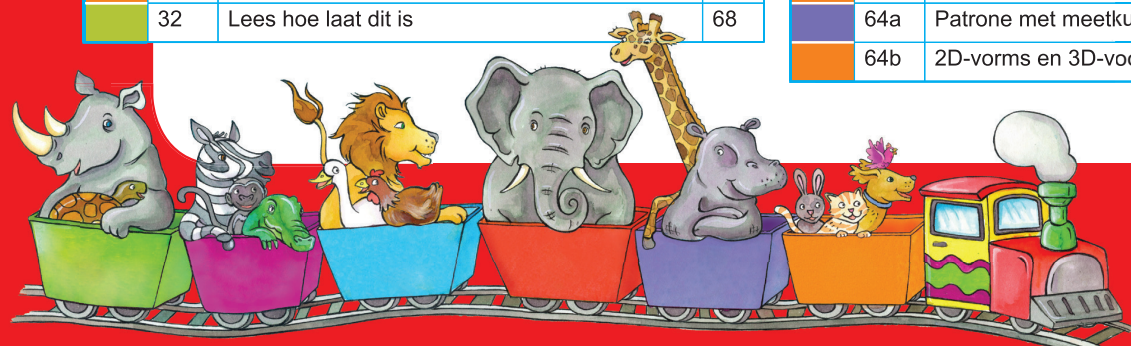

Graad I



W i s k u n d e

IN AFRIKAANS

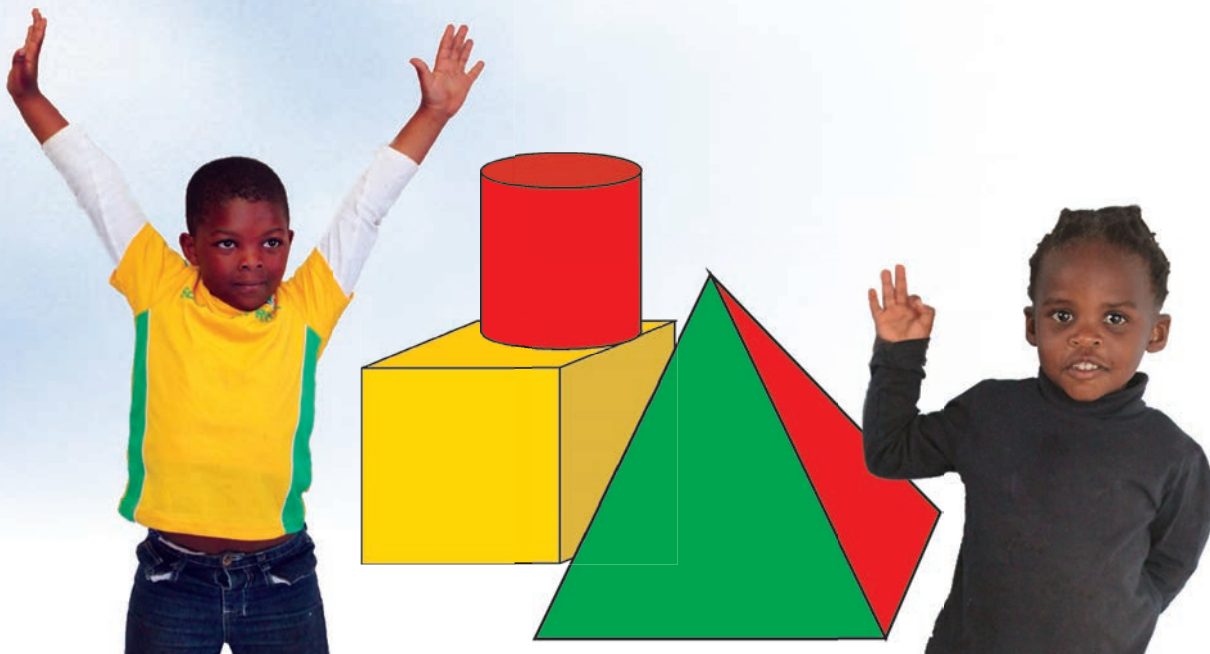

Hierdie boek behoort aan:

AFRIKAANS

Boek

—

Hersiening: Opsporing en pas



Help die meisie om haar speelgoed te vind.

BEGIN



EINDE





Pas bymekaar



Soek die prentjie wat lyk soos die prent in die eerste raam.

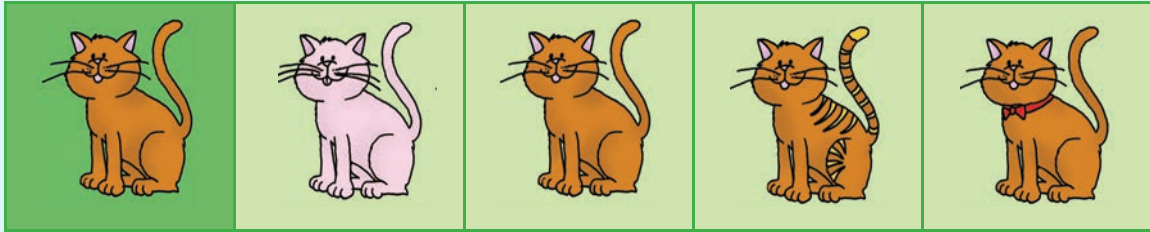
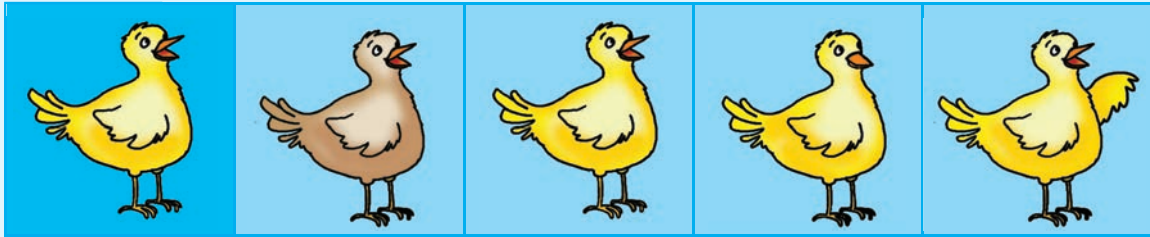

Onderwyser-
handtekening:

Datum:





Hersiening: Sorteër kleure en trek patrone na

Plaas die vorms volgens die patroon in die blokkies.

Al die vorms in die ry moet ook dieselfde kleur wees as die eerste sirkel.

Die rooi vorms is 'n voorbeeld vir jou.

Noem die kleur van elke vorm.

Gebruik die knipselbladsye agter in die boek.

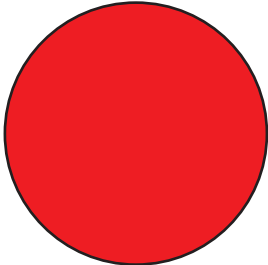
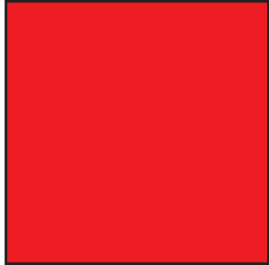
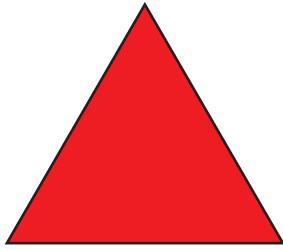
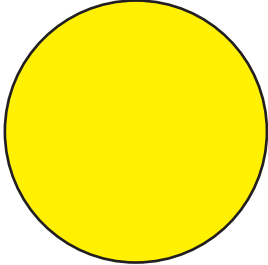
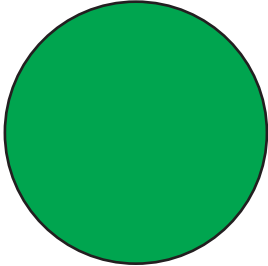
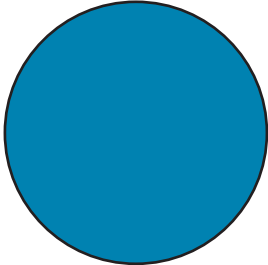



Patrone



Trek die stippellyne na om die patroon op die walvis te voltooi.

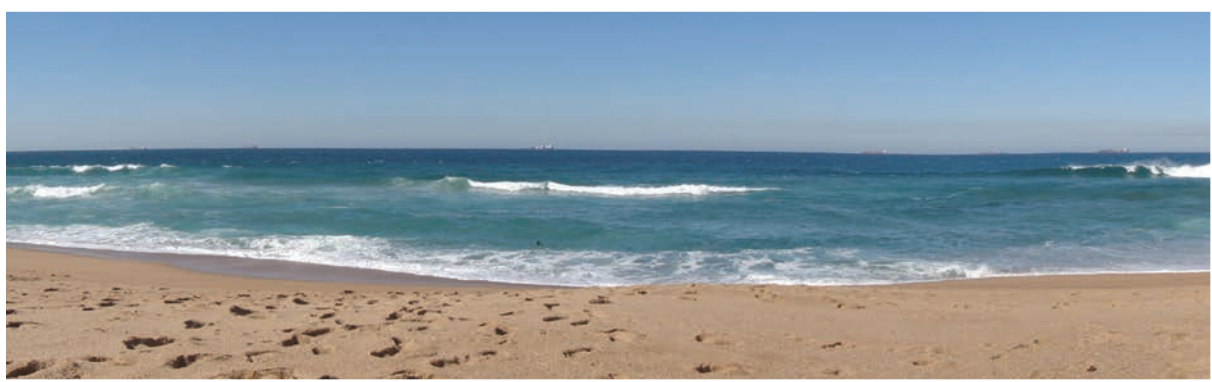
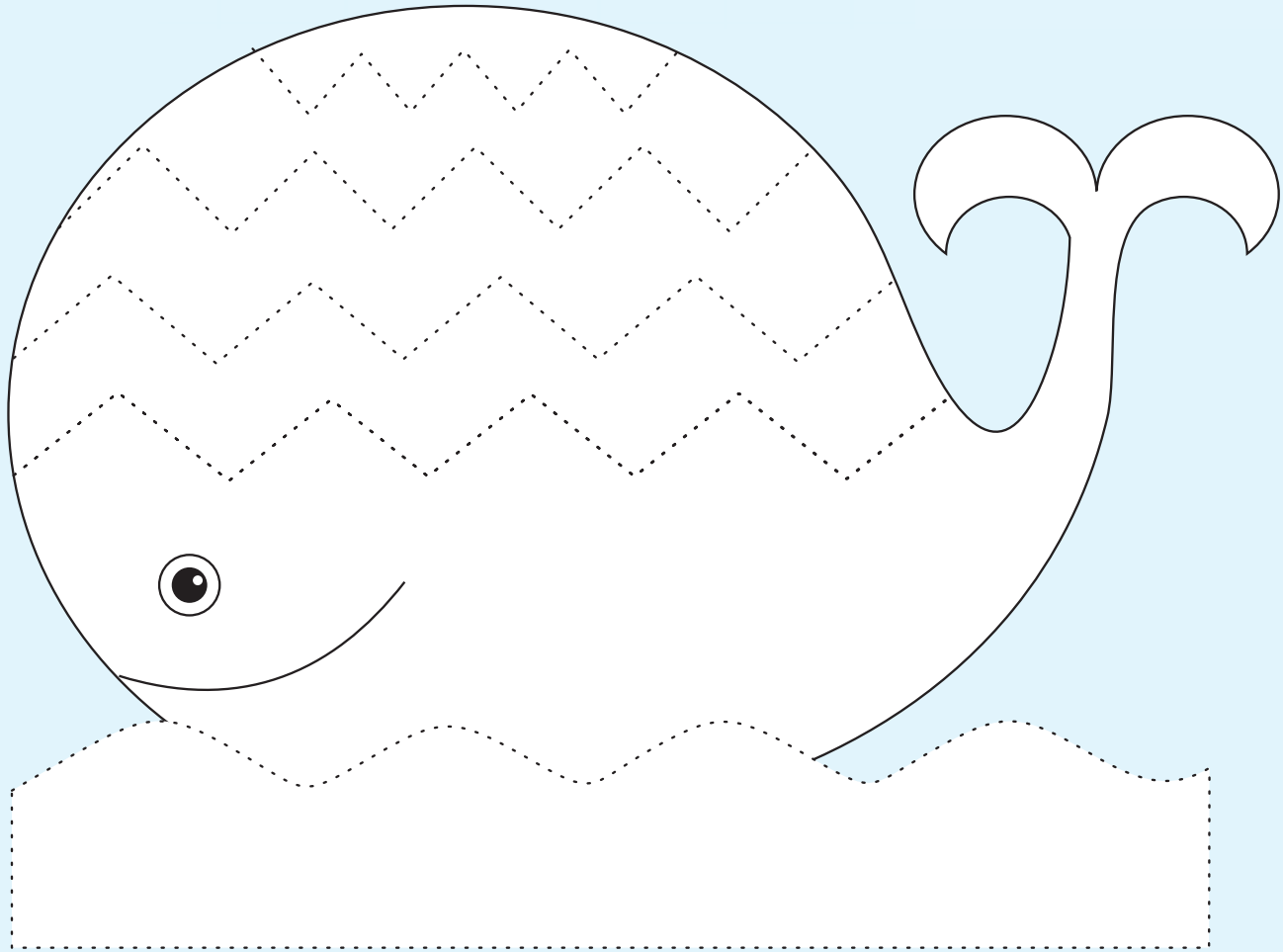

Onderwyser-
handtekening:

Datum:





Hersiening: Kleure en patrone

Trek 'n streep om die klere met dieselfde kleure te verbind.

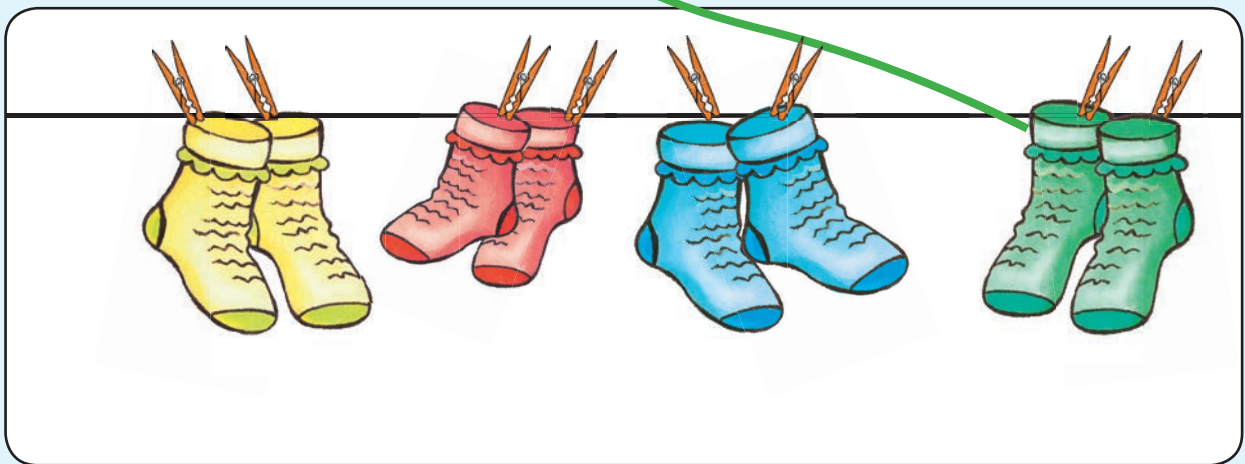
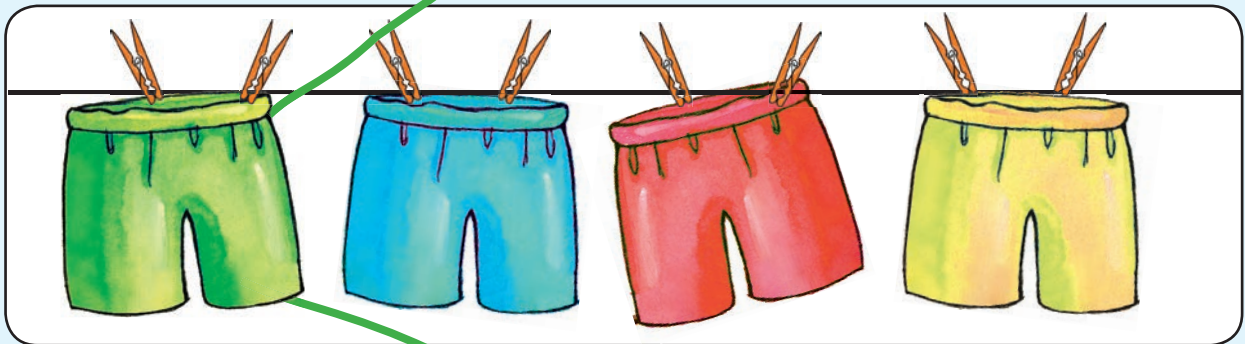
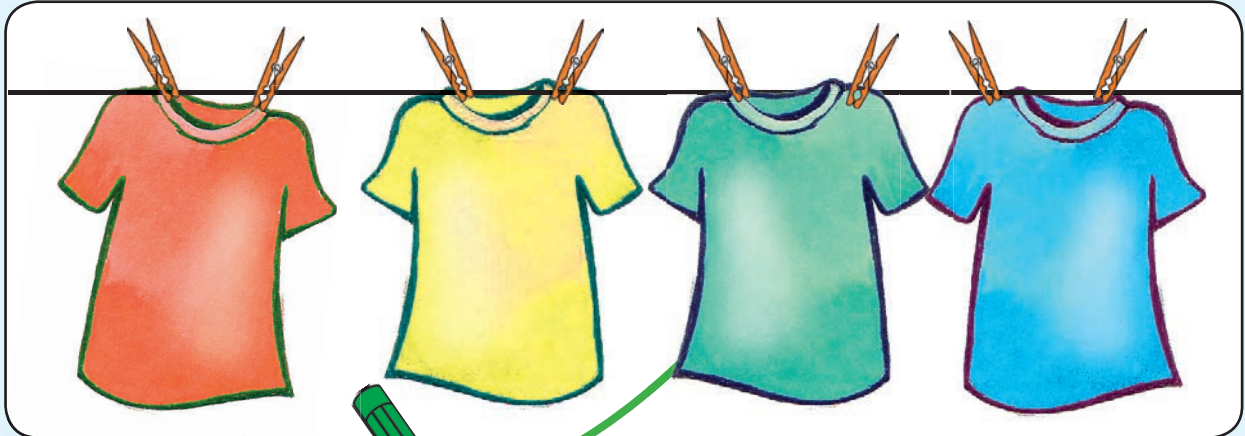



Trek die stippellynpatrone eers met jou vinger en dan met 'n kryt of potlood na.
Kopieer dan die kleiner patrone links. Die eerste patroon sal jou altyd help.



Onderwyser-
handtekening:

Datum:



Hersiening: Sorteër en pas vorms



Haal jou uitgeknipte sirkels agter in die boek uit en sit hulle op die spasies neer.

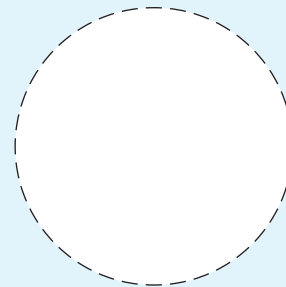
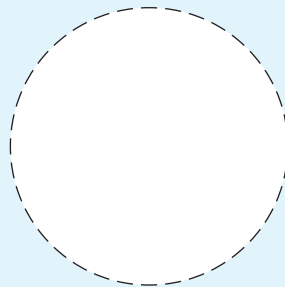
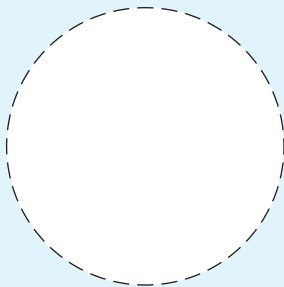
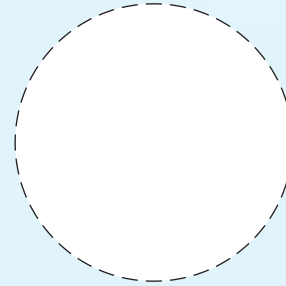
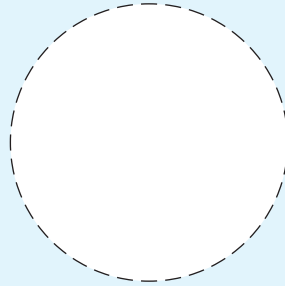
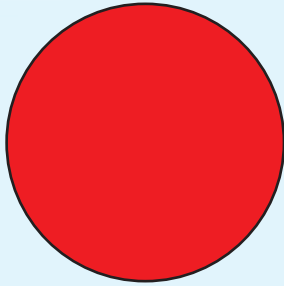

Haal jou uitgeknipte vierkante agter in die boek uit en sit hulle op die spasies neer.

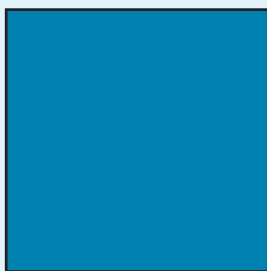



Haal jou uitgeknipte driehoeke agter in die boek uit en sit hulle op die spasies neer.

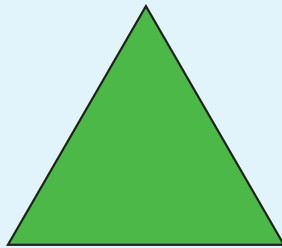

Haal jou uitgeknipte ruite agter in die boek uit en sit hulle op die spasies neer.

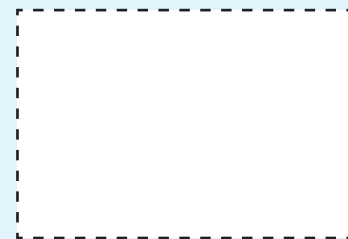
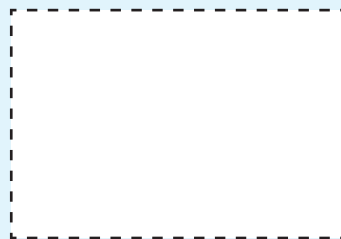
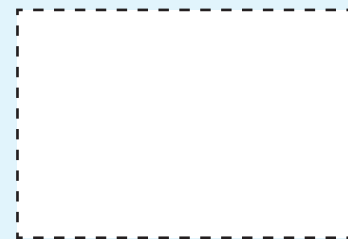
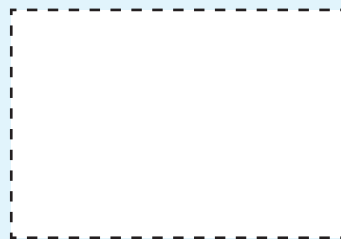
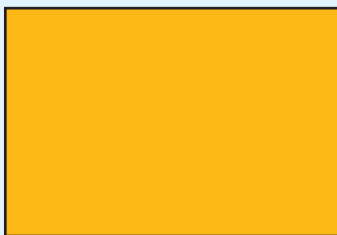

Onderwyser-handtekening:

Datum:





Hersiening: Soek en tel

Kyk na hierdie prentjies van diere.

Tel hoeveel diere daar van elke soort is en teken dieselfde aantal kolletjies in die regte blokkie op die volgende bladsy.

Ons het die een van die katte vir jou gedoen.



1 2 3 4 5 6 7 8 9 10



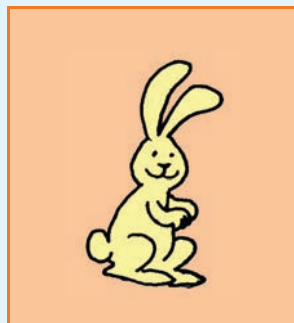
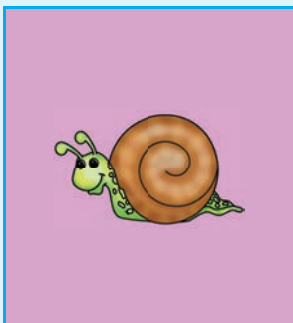
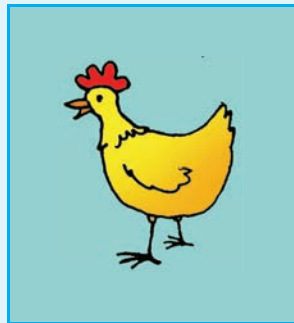
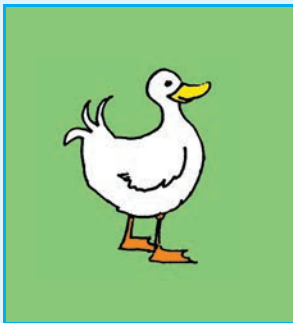
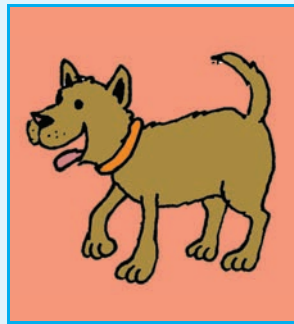
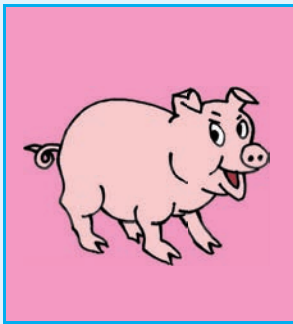
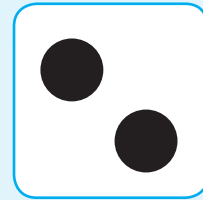
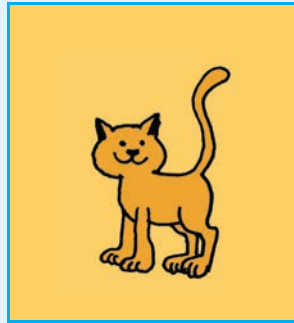
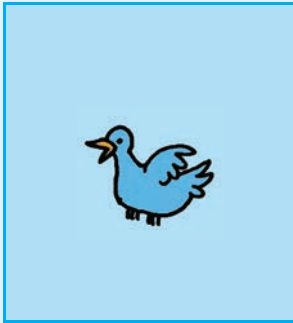

Onderwyser-
handtekening:

Datum:



Hersiening: Posisies



Trek 'n kring om die dier om te wys dat dit in dieselfde posisie as die groen blokkie in die ry is. Die eerste een is vir jou as voorbeeld gedoen.

Row of 5 orange fish on a blue background. The 3rd fish is circled in red. A red arrow points from a green block in the row above to the circled fish. A red pencil is shown pointing to the circle.

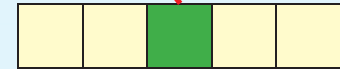

Omkring die dier op dieselfde plek as die groen blokkie in die ry.

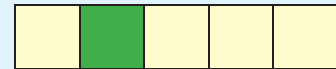

Row of 5 grey monkeys on a yellow background. The 3rd monkey is circled in red.

Omkring die dier op dieselfde plek as die groen blokkie in die ry.

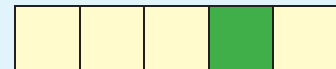

Row of 5 grey elephants on a green background. The 4th elephant is circled in red.

Omkring die dier op dieselfde plek as die groen blokkie in die ry.

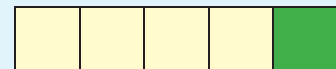

Row of 5 bees on a red background. The 4th bee is circled in red.





Trek die patrone eers met jou vinger na en dan met 'n kryt of potlood.
Die eerste patroon sal jou altyd help.

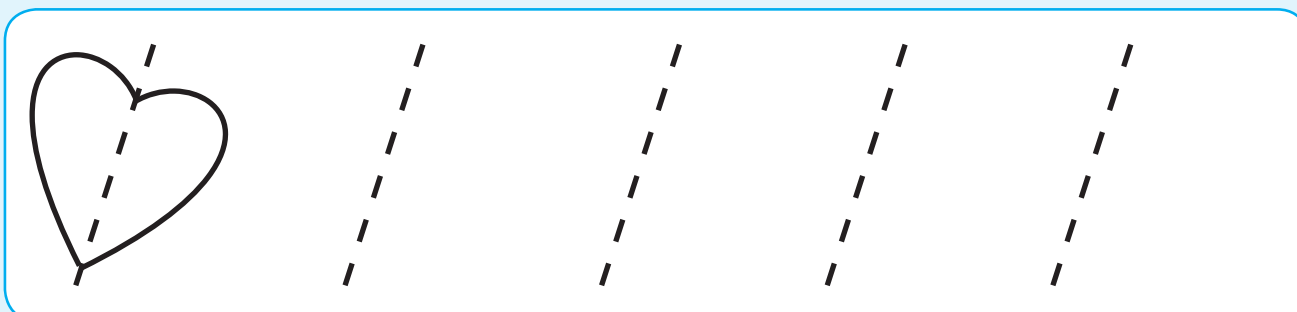
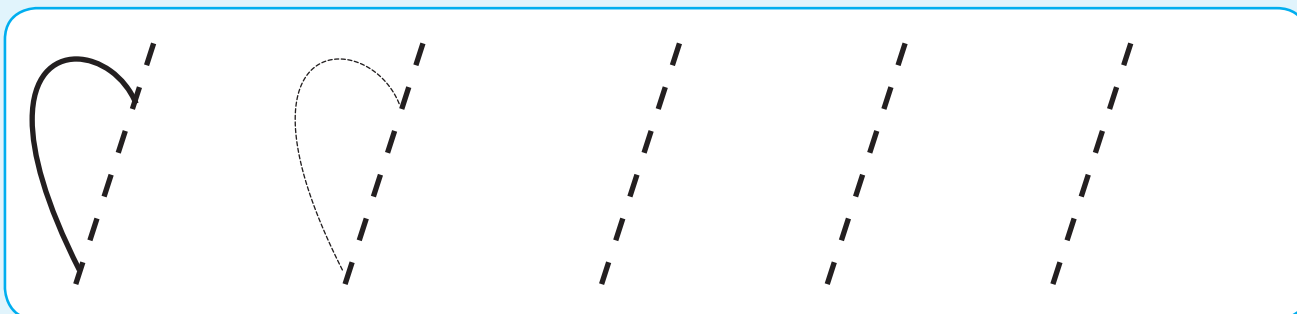
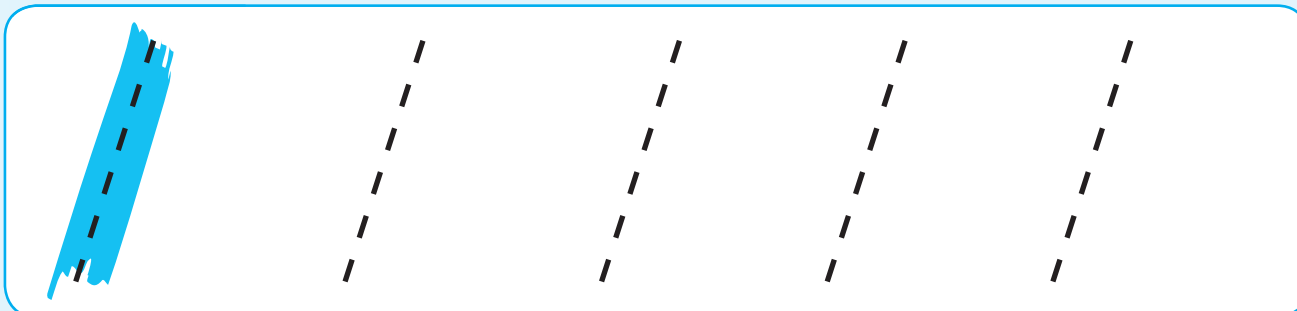

Onderwyser-
handtekening:

Datum:



Hersiening: Tyd

Kyk na die prente en sê wat langer en wat korter neem om te doen. Maak 'n regmerk (✓) by die dinge wat langer neem. Maak 'n kruisie (✗) by die dinge wat korter neem.



Ons loop skool toe.



Ons ry skool toe.



Ons maak 'n toebroodjie.



Ons bak 'n koek.



Ons werk by die skool.



Ons speel sokker.



Ons verf die huis.



Ons skilder 'n prentjie.



Trek die patrone eers met jou vinger na en dan met 'n kryt of potlood.
Die eerste patroon in die ry sal jou altyd help.

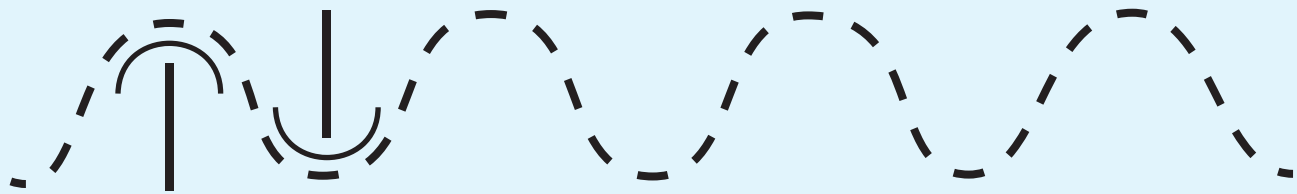
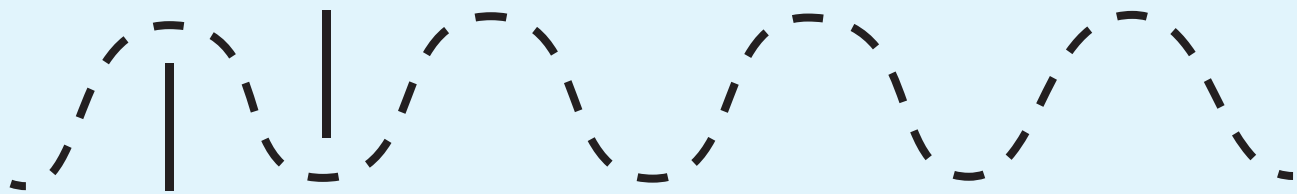
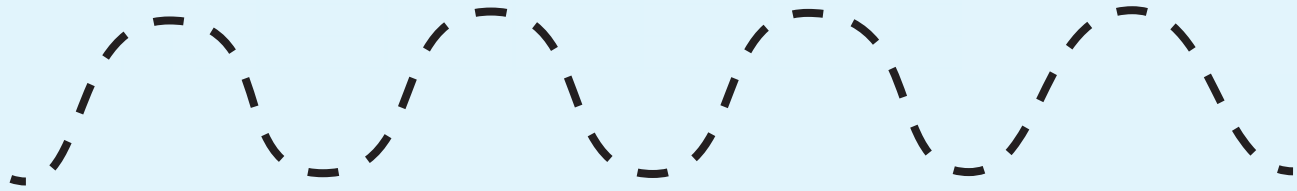

Onderwyser-
handtekening:

Datum:



Hersiening: Vorms, groottes en kleure

Omkring die grootste voorwerp in elke prentjie.

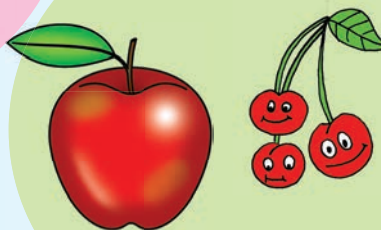
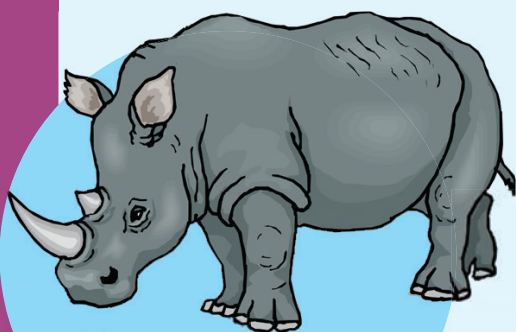
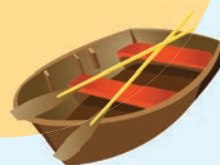



Kleure

Omkring die voorwerpe met dieselfde kleur as die verfstreek in die eerste blokkie.

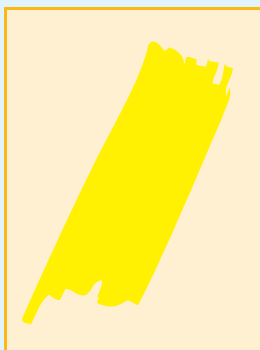
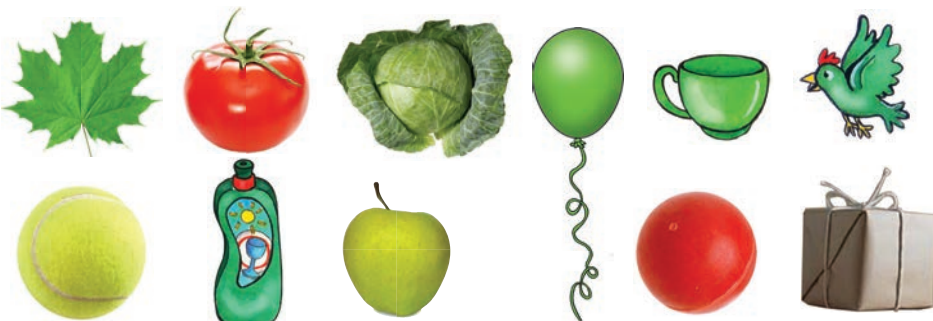
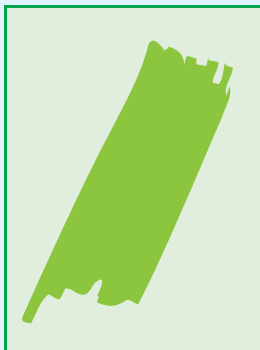
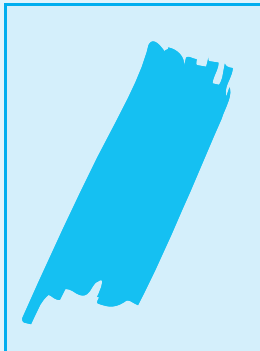
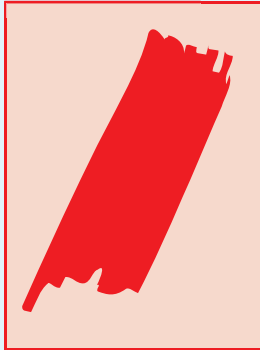

Onderwyser-handtekening:

Datum:



9

Kwartaal I

Een



Tel die voorwerpe in die prentjie. Trek die naam van die getal na.

een by
een meisie
een hut
een bal



Trek die nommer na.



Verbind dieselfde prentjies met mekaar.

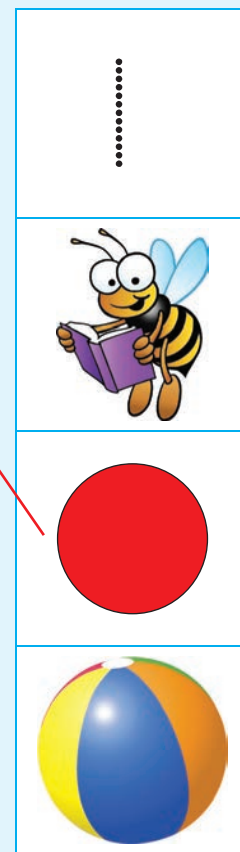
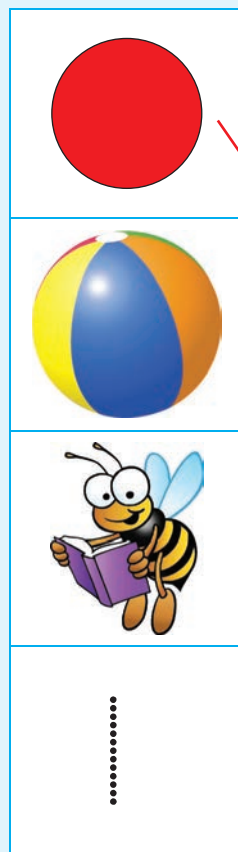
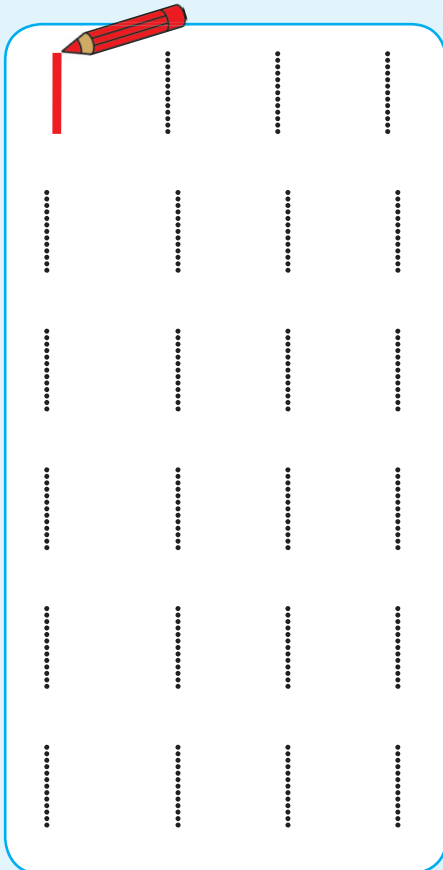

1 2 3 4 5 6 7 8 9 10





Kleur I vorm in elke blokkie in.

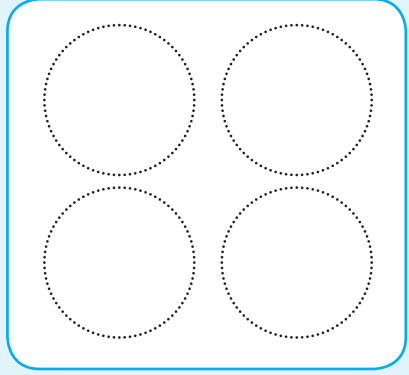
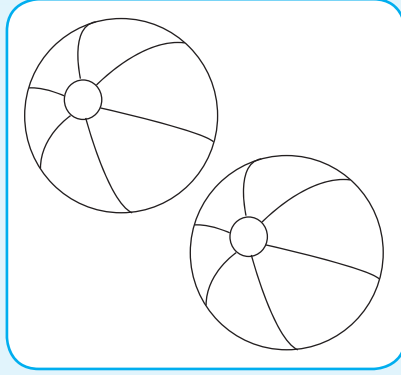
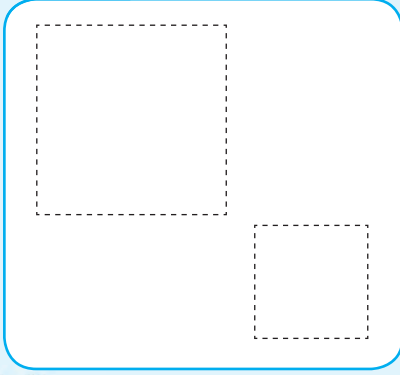

Kopieer dit en teken nog I.

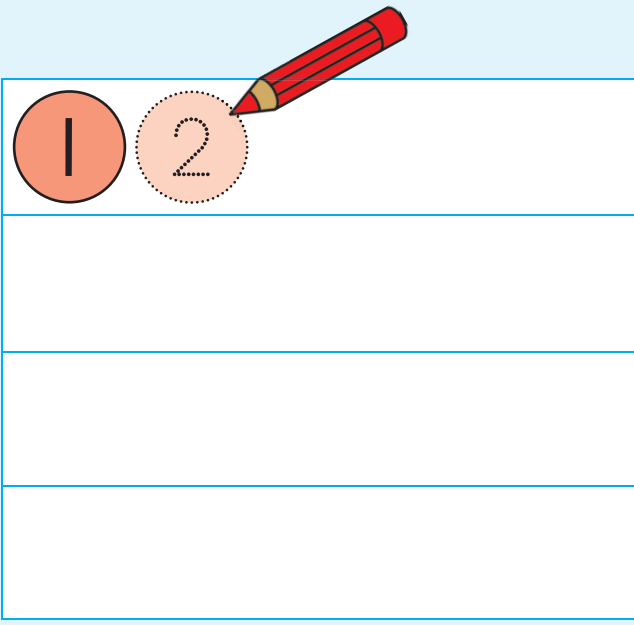
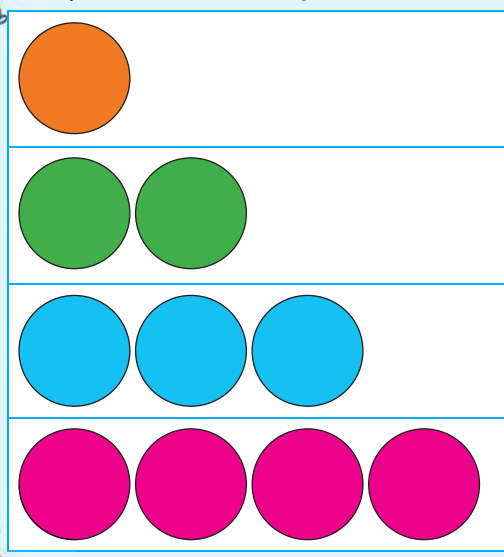

Oefen die getal.

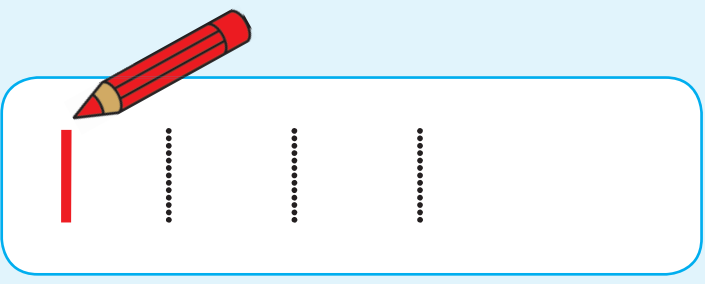
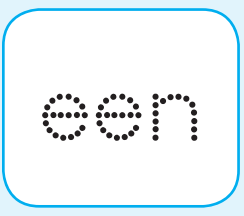

Tel die sirkels terwyl jy hulle inkleur.

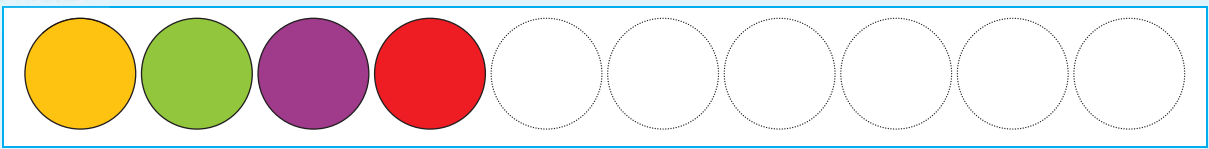

Onderwyser-handtekening:
Datum:



Twee



Tel die voorwerpe in die prentjie. Trek die naam van die getal na.

twee bome
 twee seuns
 twee vlieërs
 twee honde

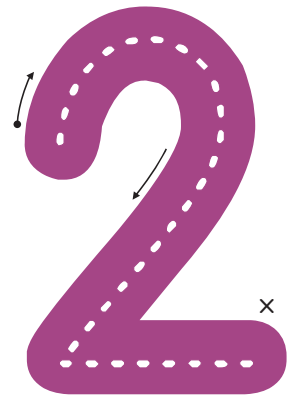

Trek die nommer na.



Verbind dieselfde prentjies met mekaar.

Tracing practice for the number 2. It features a red pencil pointing to a solid red number 2, followed by six rows of three dashed number 2s for tracing.

Matching exercise for the number 2. It consists of five boxes: the first two contain two green squares, the next two contain two gift boxes, and the last one contains a dashed number 2.

Matching exercise for the number 2. It consists of five boxes: the first one contains a dashed number 2, the next two contain two gift boxes, and the last one contains two green squares.





Kleur 2 vorms in elke blokkie in.

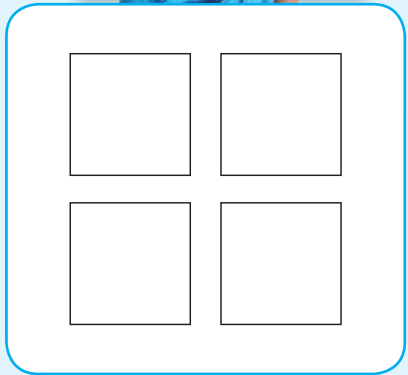
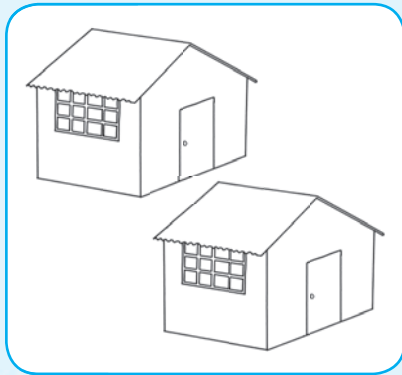

Kopieer dit en teken nog 2.

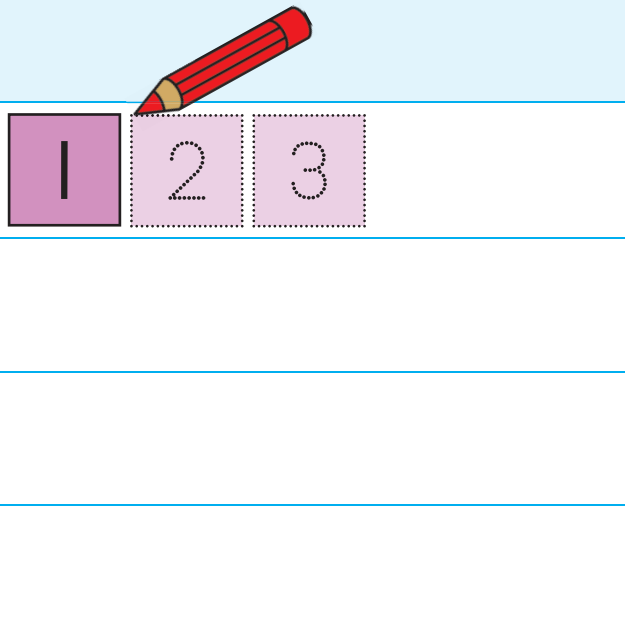
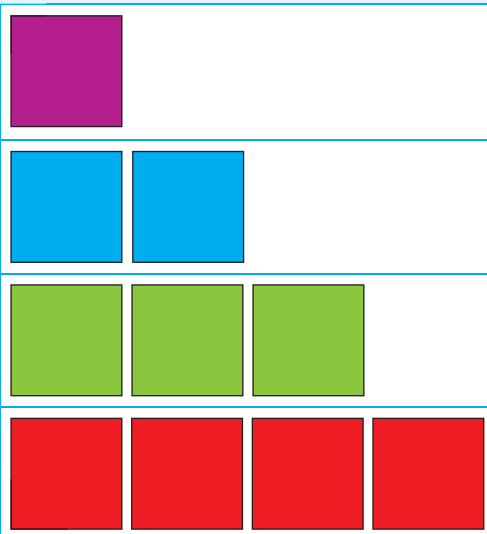

Oefen die getal.



twee



Tel die vierkante terwyl jy hulle inkleur.

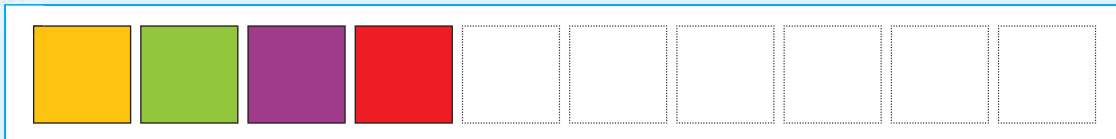

Onderwyser-handtekening:
Datum:



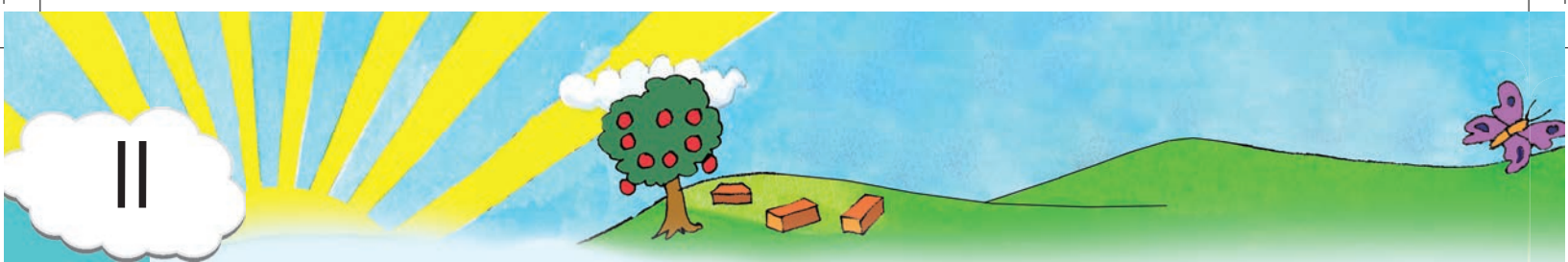

Drie



Tel die voorwerpe in die prentjie. Trek die naam van die getal na.

drie eende
 drie slakke
 drie blomme
 drie wurms

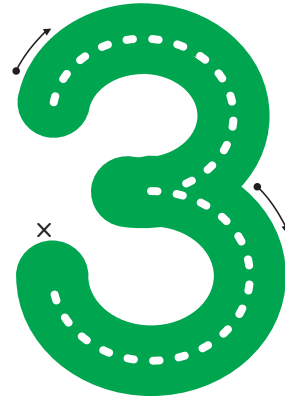
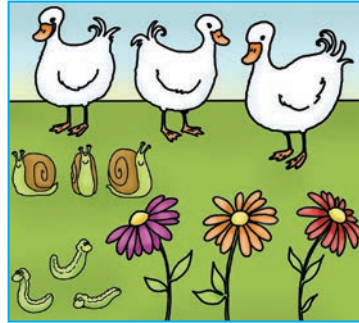

Trek die nommer na.



Verbind dieselfde prentjies met mekaar.





Kleur 3 vorms in elke blokkie in.

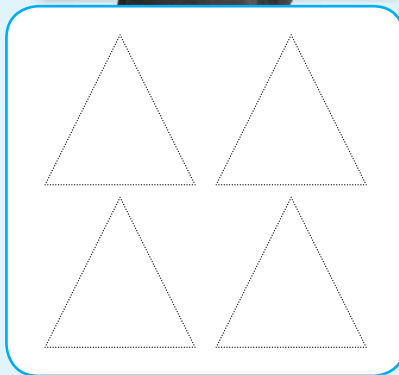
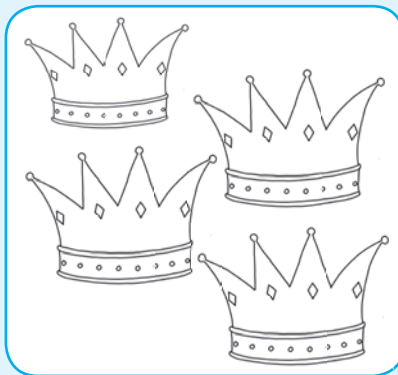

Kopieer dit en teken nog 3.

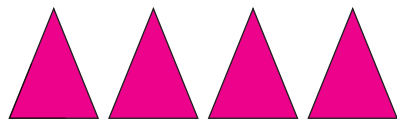
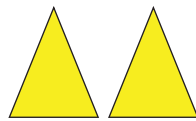

Oefen die getal.



drie



Tel die driehoeke terwyl jy hulle inkleur.

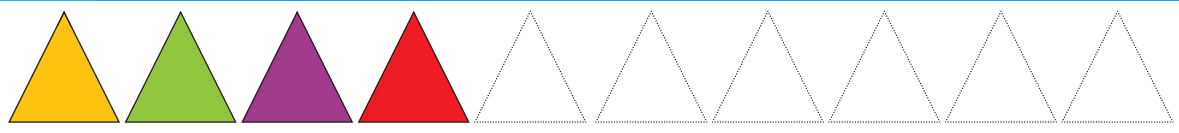





Onderwyser-handtekening:

Datum:





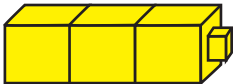
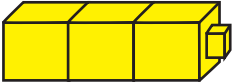
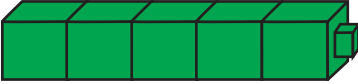

Lengte en posisie

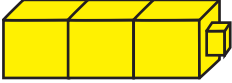

Merk (✓) die kortste trein.

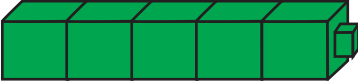

 <input type="checkbox"/>	 <input type="checkbox"/>	 <input type="checkbox"/>
 <input type="checkbox"/>	 <input type="checkbox"/>	 <input type="checkbox"/>

Merk (✓) die langste trein.

 <input type="checkbox"/>	 <input type="checkbox"/>	 <input type="checkbox"/>
 <input type="checkbox"/>	 <input type="checkbox"/>	 <input type="checkbox"/>

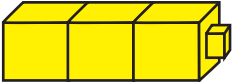

Teken 'n trein wat langer is.





Kleur die korrekte woord in. Die kort trein is:

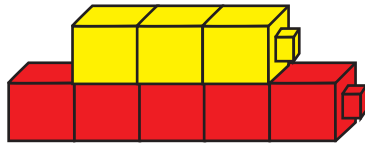

voor

bo-op

agter

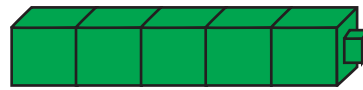
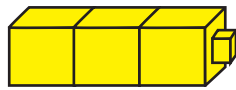

voor

bo-op

agter

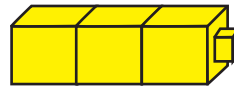

voor

bo-op

agter



Teken 'n langer trein.

bo-op

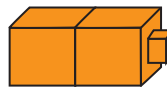

langsaan



voor



Onderwyser-handtekening

Datum:

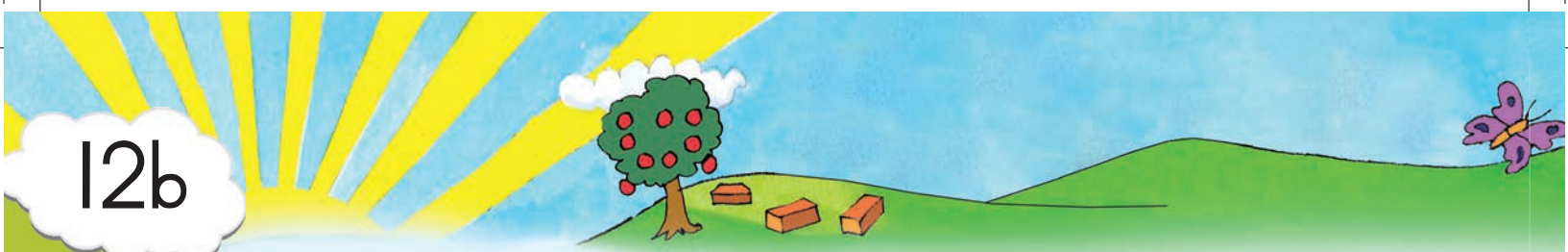

Lengte



Omkring die kortste voorwerp in elke prent.

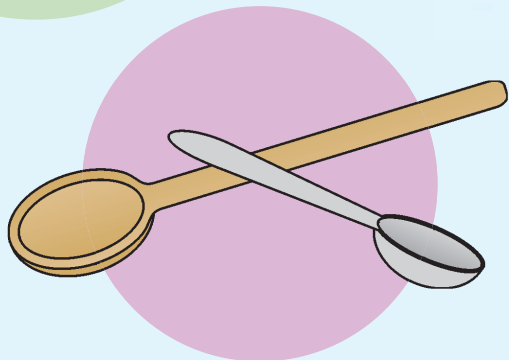
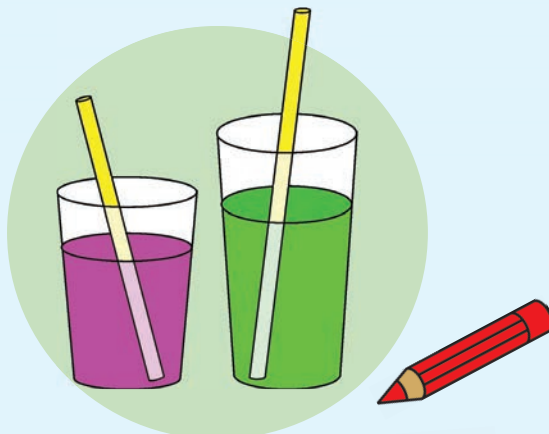
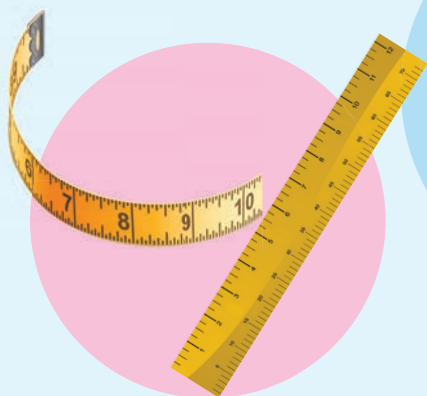

kort	lank
------	------

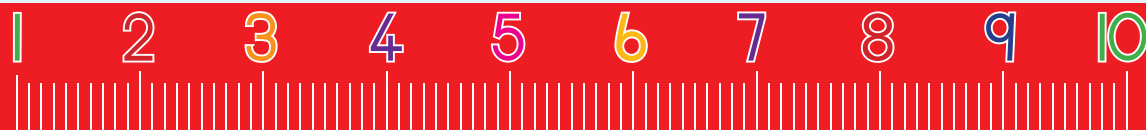



Merk die regte antwoord.

Merk die hoogste toring.

<p>4 3 2 1</p> <p><input type="checkbox"/> <input type="checkbox"/></p>	<p>3 2 1</p> <p><input type="checkbox"/> <input type="checkbox"/></p>	<p>3 2 1</p> <p><input type="checkbox"/> <input type="checkbox"/></p>
---	---	---

Merk die kortste potlood.

<p><input type="checkbox"/> <input type="checkbox"/></p>	<p><input type="checkbox"/> <input type="checkbox"/></p>	<p><input type="checkbox"/> <input type="checkbox"/></p>
--	--	--

Merk die vetste kryt.

<p><input type="checkbox"/> <input type="checkbox"/></p>	<p><input type="checkbox"/> <input type="checkbox"/></p>	<p><input type="checkbox"/> <input type="checkbox"/></p>
--	--	--



Teken een gebou wat korter is en een wat langer is as die gebou hieronder.

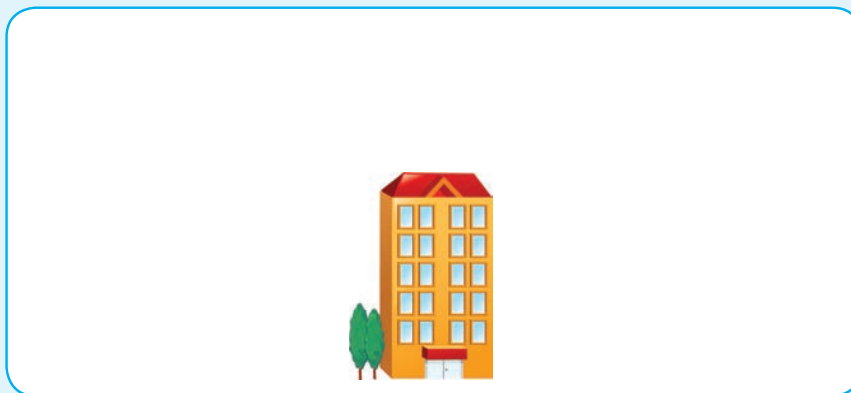

Teken een rivier wat wyer is en een wat smaller is as die een in die prentjie.



Onderwyser-
handtekening













Datum:



Vergelyk getal 1-3















Merk die blokkies wat dieselfde getal voorwerpe in het.

 <input type="checkbox"/>	 <input type="checkbox"/>	 <input type="checkbox"/>	 <input type="checkbox"/>
 <input type="checkbox"/>	 <input type="checkbox"/>	 <input type="checkbox"/>	 <input type="checkbox"/>
 <input type="checkbox"/>	 <input type="checkbox"/>	 <input type="checkbox"/>	 <input type="checkbox"/>



Merk die blok of blokkies met meer voorwerpe as die ingekleurde blok.

 <input type="checkbox"/>	 <input type="checkbox"/>	 <input type="checkbox"/>	 <input type="checkbox"/>
 <input type="checkbox"/>	 <input type="checkbox"/>	 <input type="checkbox"/>	 <input type="checkbox"/>
 <input type="checkbox"/>	 <input type="checkbox"/>	 <input type="checkbox"/>	 <input type="checkbox"/>





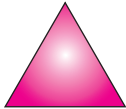
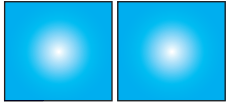

Kopieer en teken nog 'n vorm aan die regterkant.



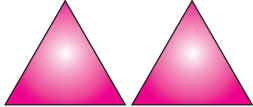

Teken een minder vorm aan die regterkant.



Teken een minder vorm aan die regterkant.

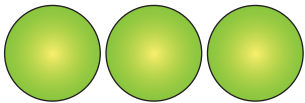

Trek die kleinste van die drie getalle na.

		
---	---	---



Onderwyser-
handtekening:

Datum:





Vier



Tel die voorwerpe in die prentjie. Trek die naam van die getal na.

vier katte
 vier miere
 vier blare
 vier goggas

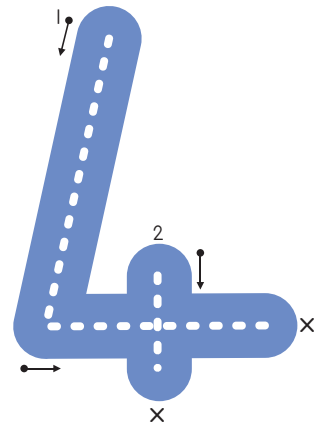
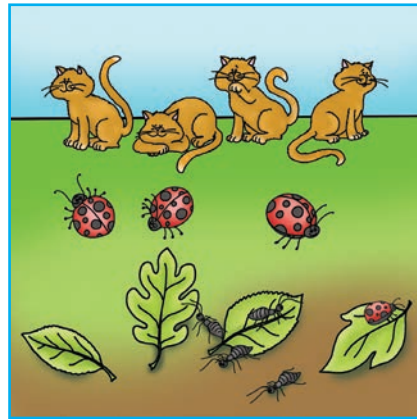

Trek die nommer na.



Verbind die prentjies wat dieselfde lyk.





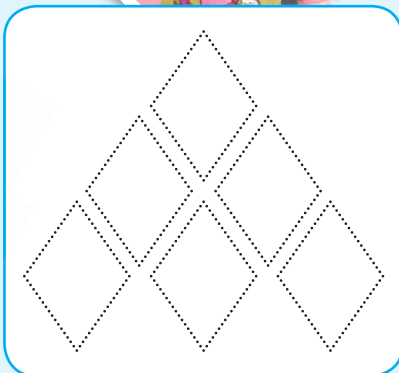
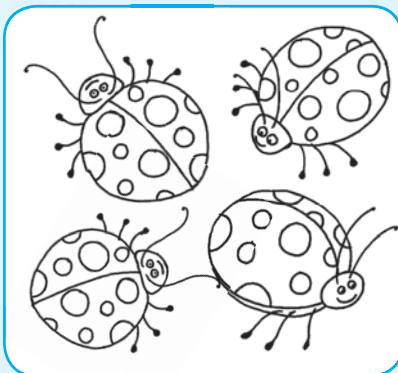

Kleur 4 voorwerpe in elke blokkie in.



Kopieer en teken nog 4 vorms en kleur hulle in.

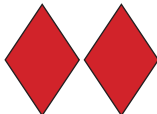
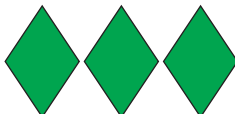
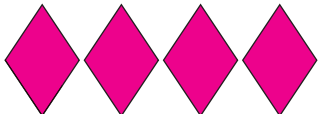

Oefen die getal.



vier



Tel die ruite terwyl jy hulle inkleur.

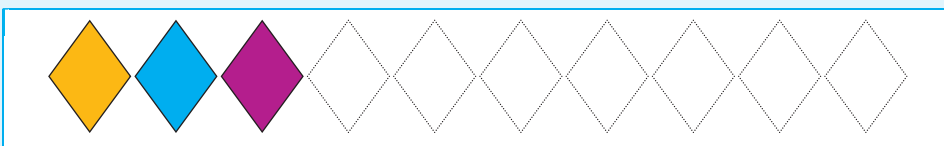

Onderwyser-handtekening:

Datum:



Tel by en trek af tot by 4



Voltooi die volgende deur 'n tekening te maak.

	en		maak	<input type="text"/>		en	<input type="text"/>	maak	
	en		maak	<input type="text"/>		en	<input type="text"/>	maak	
	en		maak	<input type="text"/>		en	<input type="text"/>	maak	



Hoeveel tellers bly oor?
Teken hulle.



Teken nog tellers om 4 te maak.



Skryf 'n getaltesin vir:

	<input type="text" value="4"/>	minus	<input type="text" value="1"/>	is	<input type="text" value="3"/>
	<input type="text"/>	minus	<input type="text"/>	is	<input type="text"/>
	<input type="text"/>	minus	<input type="text"/>	is	<input type="text"/>





Tel dit bymekaar en vul dan die antwoord in.



en

1 en 2 is

3

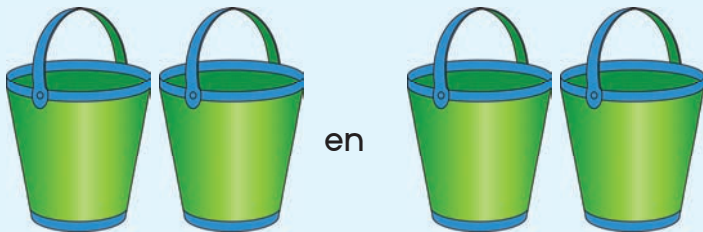

en

2 en 2 is



en

3 en 1 is



en

1 en 3 is

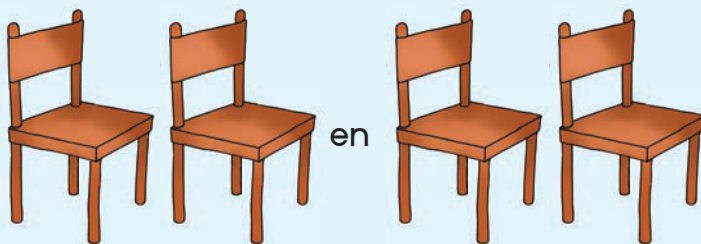

en

2 en 2 is



Onderwyser-
handtekening:

Datum:





Tyd



Skryf die getalle 1 tot 4 in die blokkies om te wys hoe 'n mens groei.







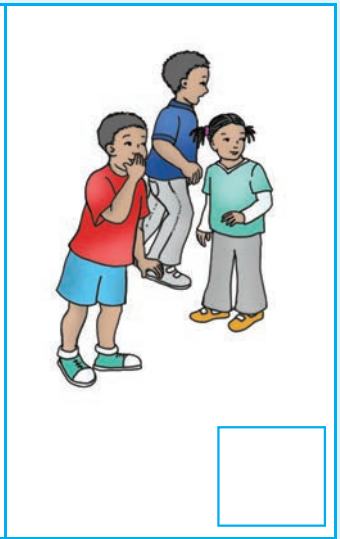



Merk die een wat jy die vinnigste sal doen.

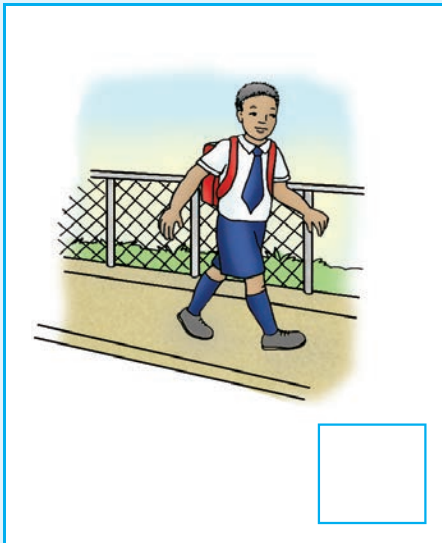

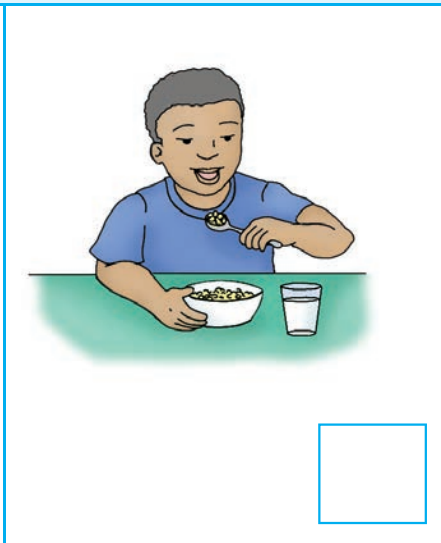





1

2

3

4

1

2

3

4





Teken iets:

a. wat jy gister gedoen het

b. wat jy vandag gedoen het

c. wat jy môre gaan doen



Onderwyser-
handtekening:

Datum:





Vyf



Tel die voorwerpe in die prentjie. Trek die naam van die getal na.

vyf teddiebere
 vyf lekkers
 vyf sterre
 vyf strepe

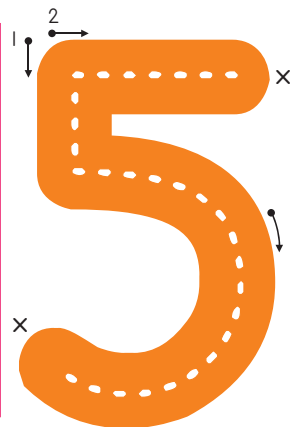

Trek die getal na.



Verbind die prentjies wat dieselfde lyk.

Tracing practice for the number 5. It features a red pencil pointing to a solid red '5', followed by three columns of five dotted '5's for tracing.

Matching exercise 1. It consists of four boxes. The first box contains five purple eggs. The second box contains five brown eggs. The third box contains five colorful Easter eggs. The fourth box contains a dotted number 5.

Matching exercise 2. It consists of four boxes. The first box contains five colorful Easter eggs. The second box contains a dotted number 5. The third box contains five brown eggs. The fourth box contains five purple eggs.



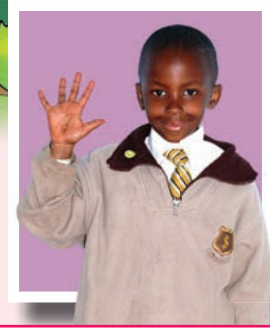
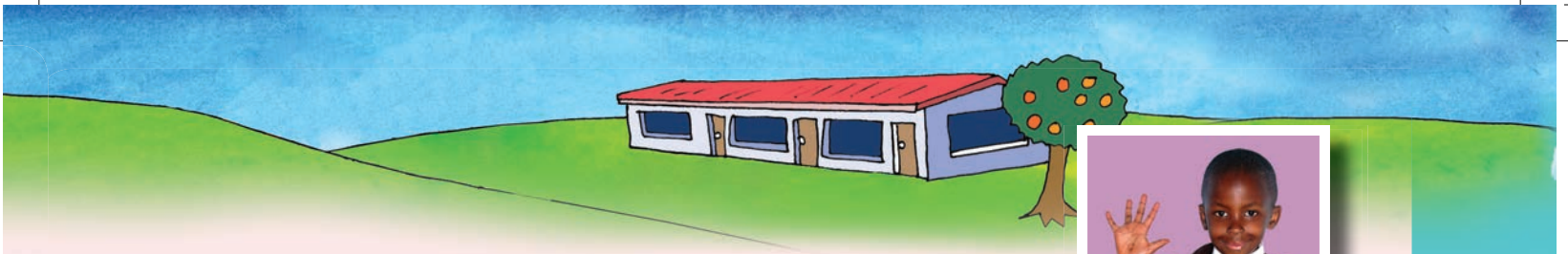

Kleur 5 voorwerpe in elke blokkie in.

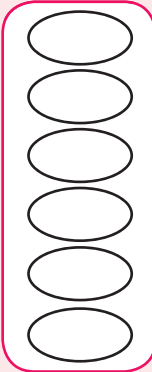

Kopieer en teken nog 5.

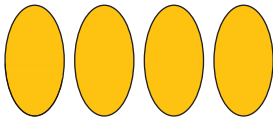
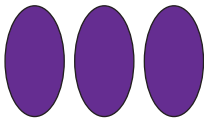
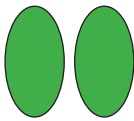
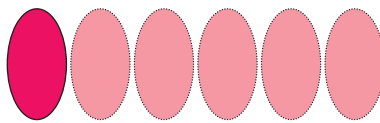

Oefen die getal.



Tel die ovale terwyl jy hulle inkleur.

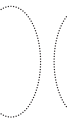

Onderwyser-handtekening:

Datum:





Hersien getalle 1 tot 5



Oefen om hierdie getalle te skryf.



Omkring die regte getalle.

	1	2	3	4	5	6	7
	1	2	3	4	5	6	7
	1	2	3	4	5	6	7
	1	2	3	4	5	6	7
	1	2	3	4	5	6	7



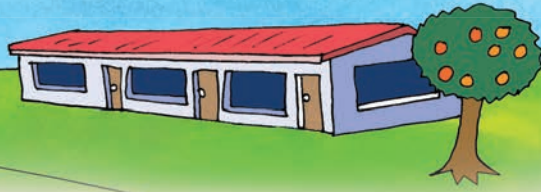

Skryf die naam van elke syfer neer.

	1	een
	2	twee
	3	drie
	4	vier
	5	vyf



Onderwyser-
handtekening:

Datum:





Tel op tot by 5

Voeg nog krale by deur nog te teken.

Teken nog een.

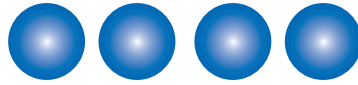

Teken nog twee.



Teken nog drie.

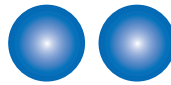

Tel en tel op, en vul die antwoord in.



en



2 en 2 is 4

2

2



en



2 en 1 is



en



3 en 2 is



en



2 en 3 is



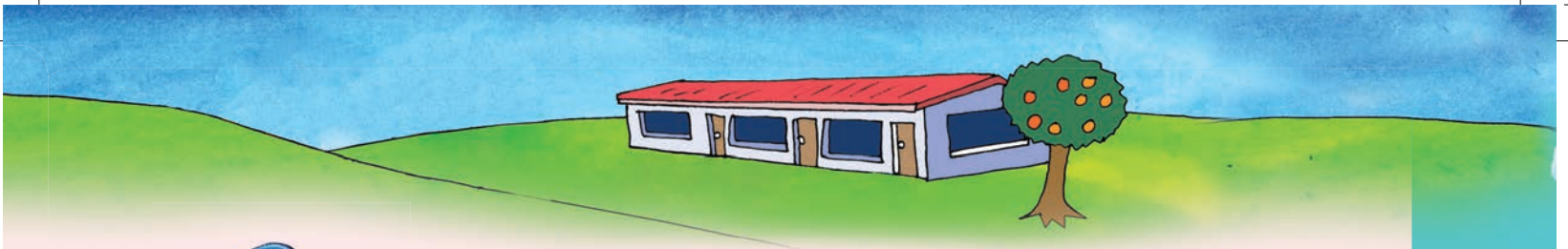

Teken nog driehoeke. Wat sien jy?

	nog 1	
	nog 2	
	nog 3	
	nog 4	



Teken die antwoord en skryf 'n som vir:

	en		gee	
3	en	2	gee	5
	en		gee	
	en		gee	
	en		gee	
	en		gee	



Onderwyser-
handtekening:

Datum:



Trek af van 5 en tel tot by 5



Teken minder.

	1 minder	
	2 minder	
	3 minder	
	4 minder	



Skryf 'n som vir:

	5	minus	1	is	4
		minus		is	
		minus		is	



Trek af deur terug te tel.

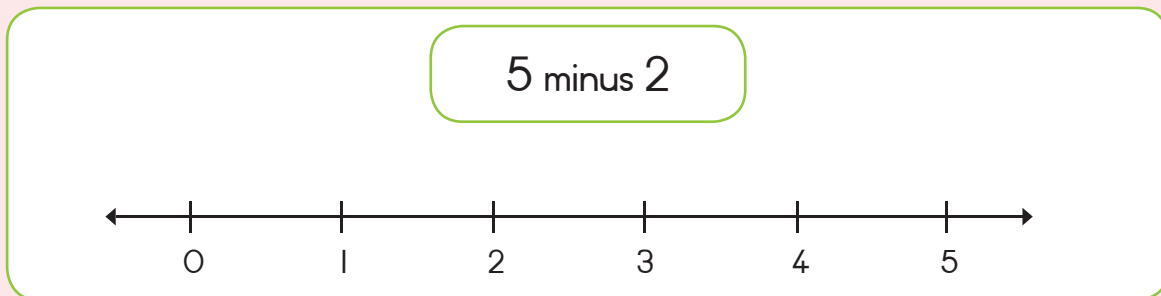
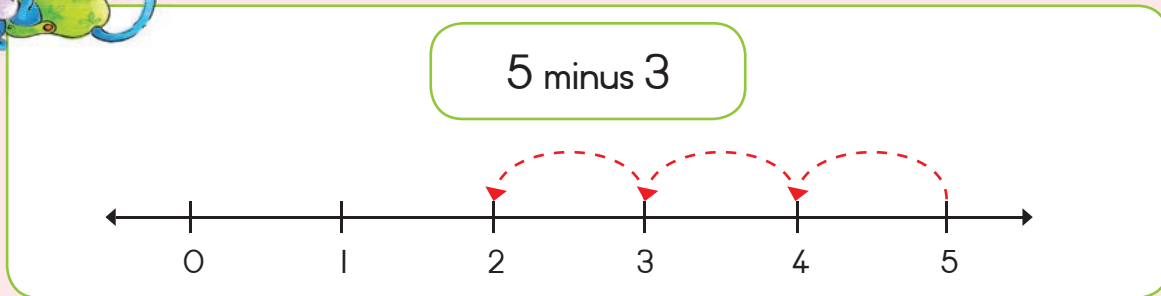

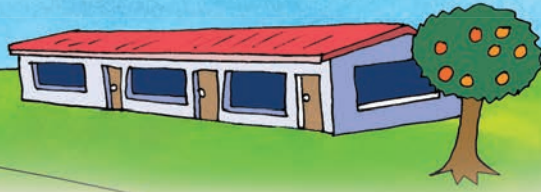

Tel by deur aan te tel.

2 plus 3

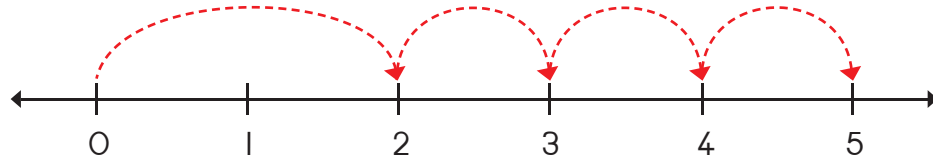

1 plus 4



Wys die som op die getallelyn.

5 minus 2

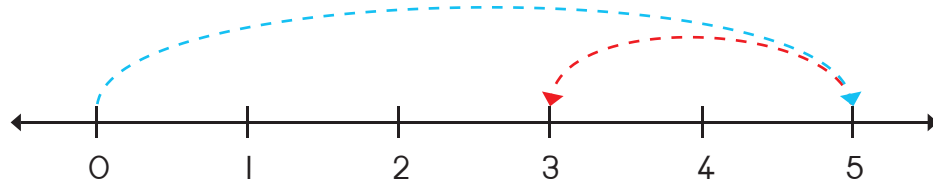

5 minus 4



Onderwyser-
handtekening:

Datum:

Tel op en trek af tot by 5



Voltooi die volgende:



en



gee my

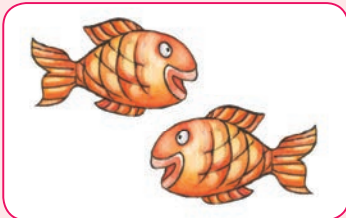

en

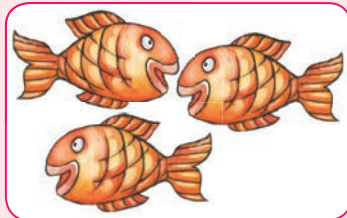

gee my



en



gee my

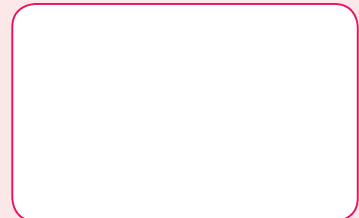

Voltooi die volgende:

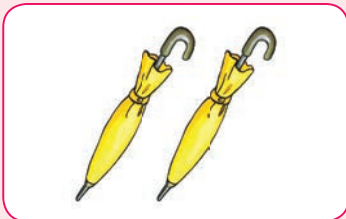

en

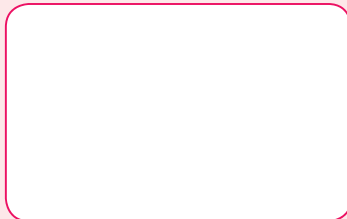

gee my

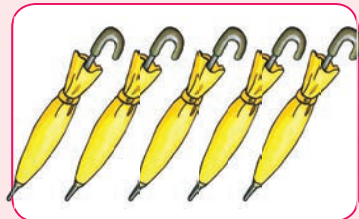

en



gee my



en

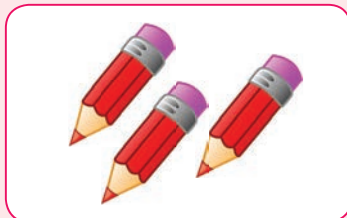

gee my

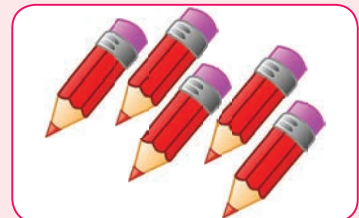



Teken nog appels om 5 te maak.

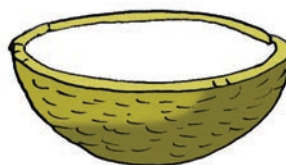
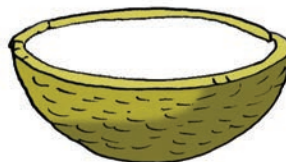

Hoeveel krale bly oor? Teken dit.

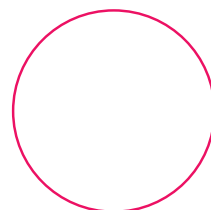
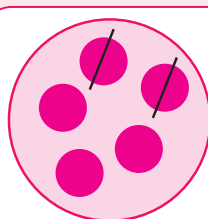
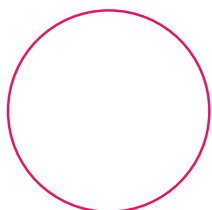
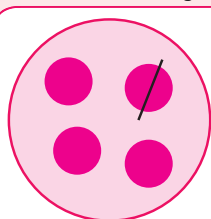

Woordprobleme.

Jou juffrou, mamma of pappa gaan dit vir jou lees en jy moet 'n tekening maak om dit op te los.

Lisa het twee pere. Musa gee vir haar een peer. Hoeveel pere het sy nou?

Lisa het vier pere. Musa gee twee pere aan Silo. Hoeveel pere het Lisa nou?



Onderwyser-
handtekening:

Datum:



Optelling en aftrekking | tot 5

Kleur die krale in om te wys:

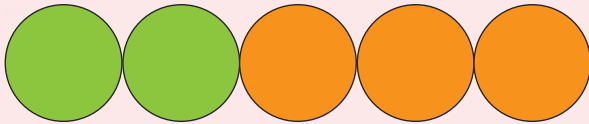

2 en 3 is 5

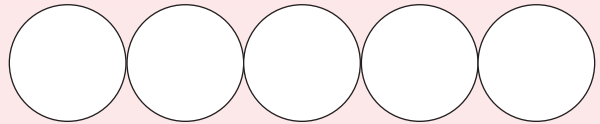

1 en 4 is 5

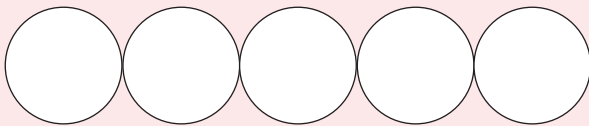

3 en 2 is 5

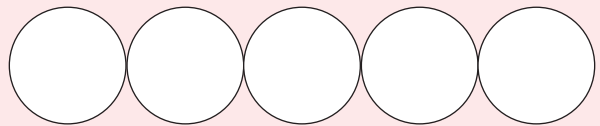

4 en 1 is 5



Trek 'n streep deur die krale om te wys:

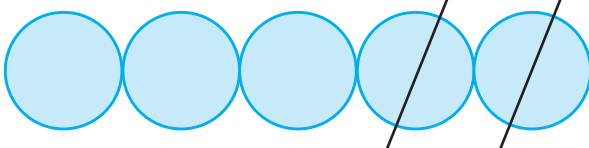

5 minus 2 is 3

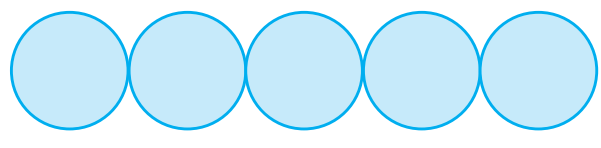

5 minus 1 is 4

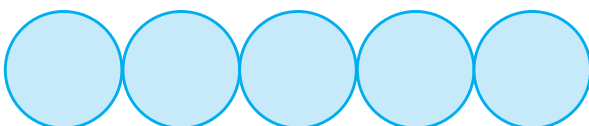

5 minus 3 is 2

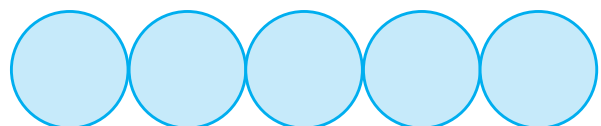

5 minus 4 is 1

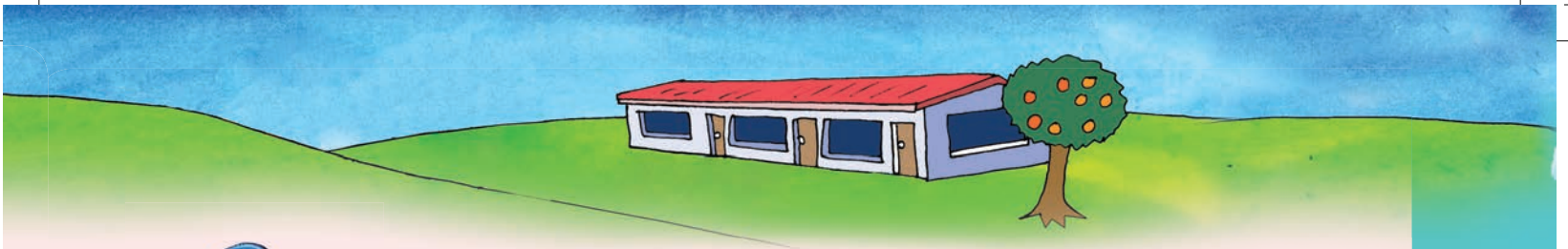

Kleur die krale in. Help die padda om dit op die getallelyn te wys.

2 en 3 is

3 en 2 is

1 en 4 is

4 en 1 is



Trek 'n streep deur die krale wat jy wegneem en wys dit op die getallelyn.

5 minus 3

5 minus 2

5 minus 1

5 minus 4



Onderwyser-handtekening:

Datum:





Balle en blokkies



Watter van die volgende prentjies lyk soos bokse?
Merk die vierkant.
Watter van die volgende prentjies lyk soos balle?
Merk die sirkel.

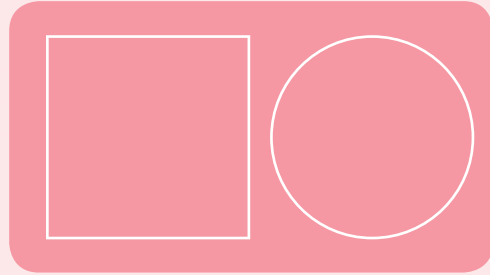

 <input type="checkbox"/> <input checked="" type="checkbox"/>	 <input type="checkbox"/> <input type="checkbox"/>	 <input type="checkbox"/> <input type="checkbox"/>
 <input type="checkbox"/> <input type="checkbox"/>	 <input type="checkbox"/> <input type="checkbox"/>	 <input type="checkbox"/> <input type="checkbox"/>
 <input type="checkbox"/> <input type="checkbox"/>	 <input type="checkbox"/> <input type="checkbox"/>	 <input type="checkbox"/> <input type="checkbox"/>



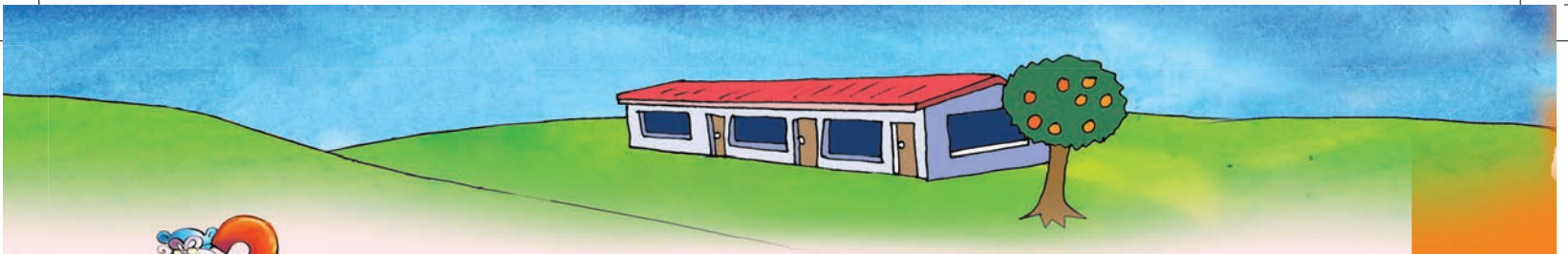

Kleur al die:

- klein boksies en balle rooi in
- groot bokse en balle blou in

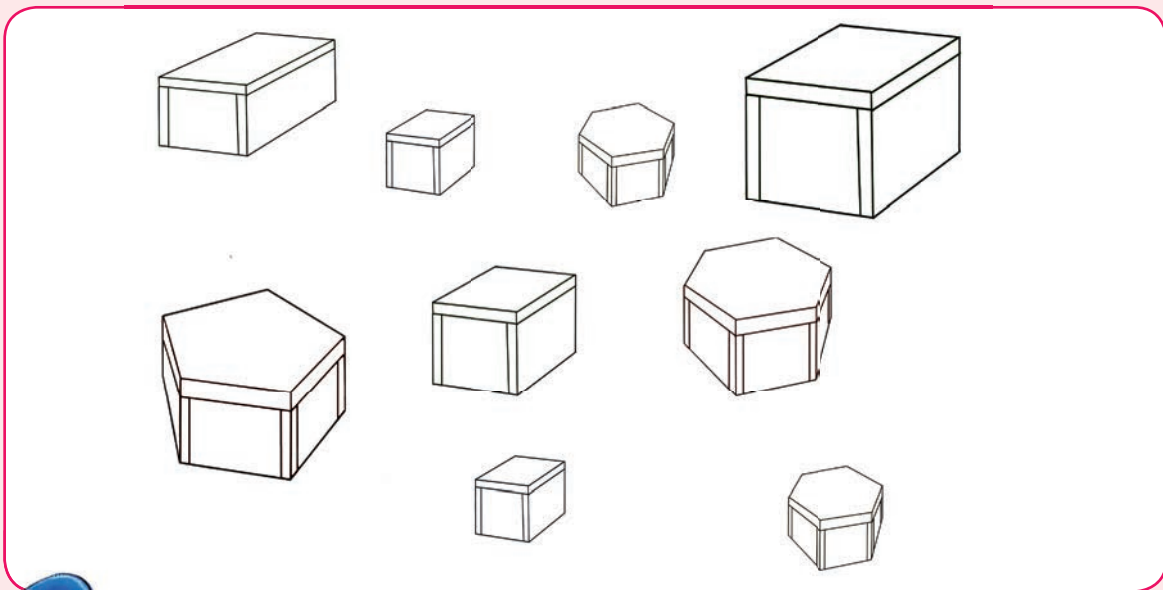
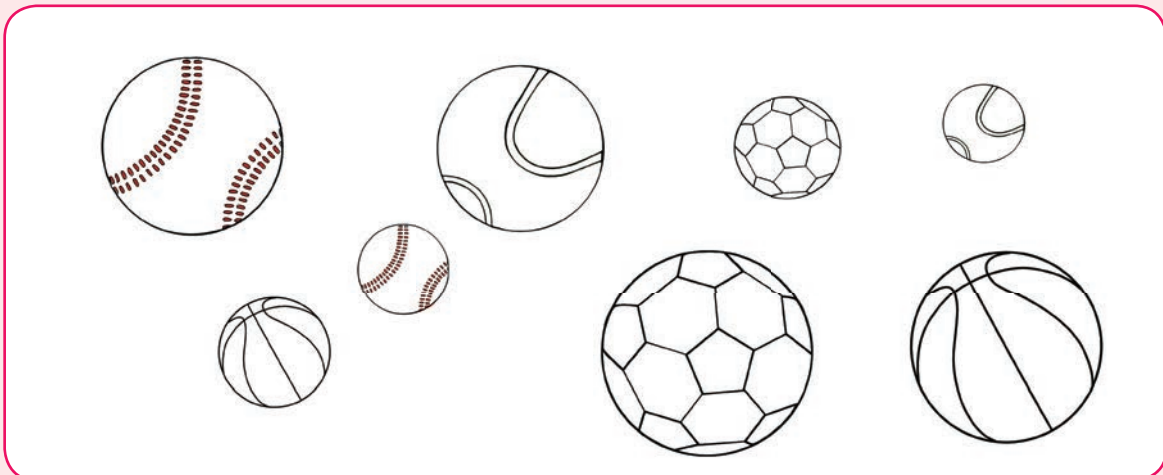

Trek die woorde na.

boks

bal



Onderwyser-
handtekening:

Datum:



Links en regs

Linkerkant

Regterkant

	Links	Regs		Links	Regs		
Die boom is	<input type="checkbox"/>	<input type="checkbox"/>	van hom.	Die hond is	<input type="checkbox"/>	<input type="checkbox"/>	van hom.
Die kar is	<input type="checkbox"/>	<input type="checkbox"/>	van hom.	Die skaap is	<input type="checkbox"/>	<input type="checkbox"/>	van hom.
Die huis is	<input type="checkbox"/>	<input type="checkbox"/>	van hom.	Die hut is	<input type="checkbox"/>	<input type="checkbox"/>	van hom.
Die voël is	<input type="checkbox"/>	<input type="checkbox"/>	van hom.	Die skool is	<input type="checkbox"/>	<input type="checkbox"/>	van hom.
Die nes is	<input type="checkbox"/>	<input type="checkbox"/>	van hom.	Die blom is	<input type="checkbox"/>	<input type="checkbox"/>	van hom.





Omkring sy regterhand.
 Omkring sy regtervoet.
 Staan soos die seuntjie en wys
 jou regterhand.

Omkring haar linkerhand.
 Omkring haar linkervoet.
 Staan soos die dogtertjie en wys
 jou linkerhand.

Regs

Links



Regs

Links



Oefen om hierdie getalle te skryf.

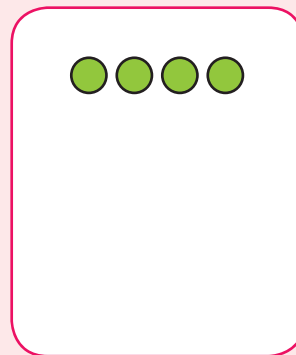
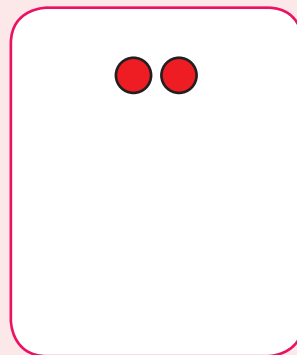
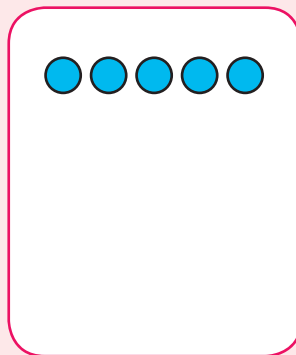
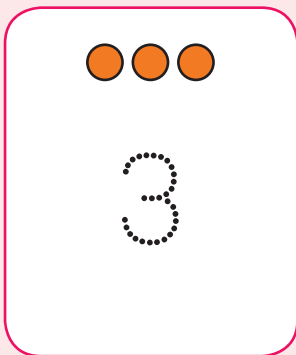

Onderwyser-
handtekening:

Datum:





Rigting

Help die hasie om die wortels te vind. Kies elke keer of sy links of regs moet draai.



links	regs
<input checked="" type="checkbox"/>	<input type="checkbox"/>



links	regs
<input type="checkbox"/>	<input type="checkbox"/>

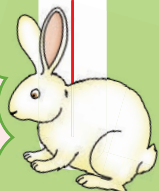

links	regs
<input type="checkbox"/>	<input type="checkbox"/>



links	regs
<input type="checkbox"/>	<input type="checkbox"/>





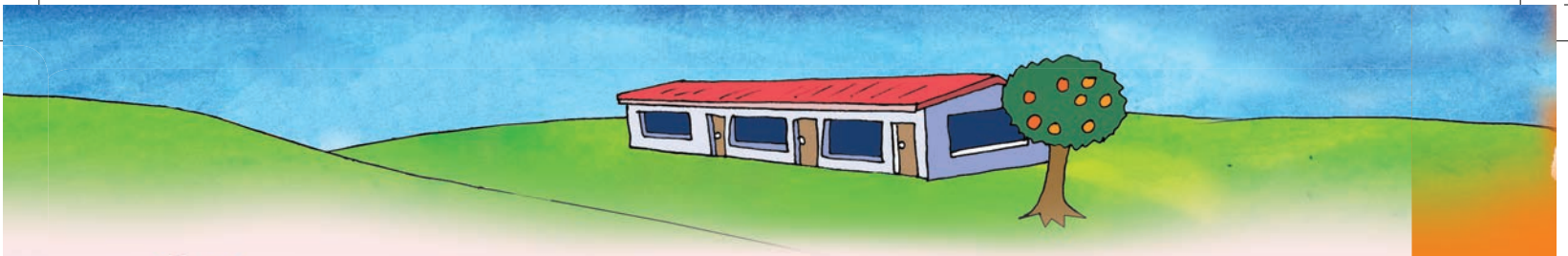

links	regs
<input type="checkbox"/>	<input type="checkbox"/>

























Kleur die korrekte woord in wat pas by die pyl.

	boontoe	links	onder toe	regs
	boontoe	links	onder toe	regs
	boontoe	links	onder toe	regs
	boontoe	links	onder toe	regs



Omkring die korrekte pyl wat pas by die eerste een in die ry.



Onderwyser-
handtekening:

Datum:





Die opbou en afbreek van getalle

Vul die regte getalle in elke blokkie in.



en is



en is



en is



en is

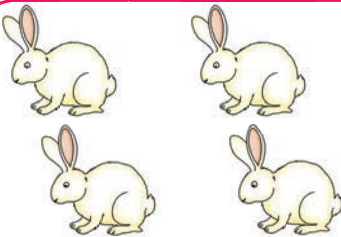

en is



en is



en is



en is



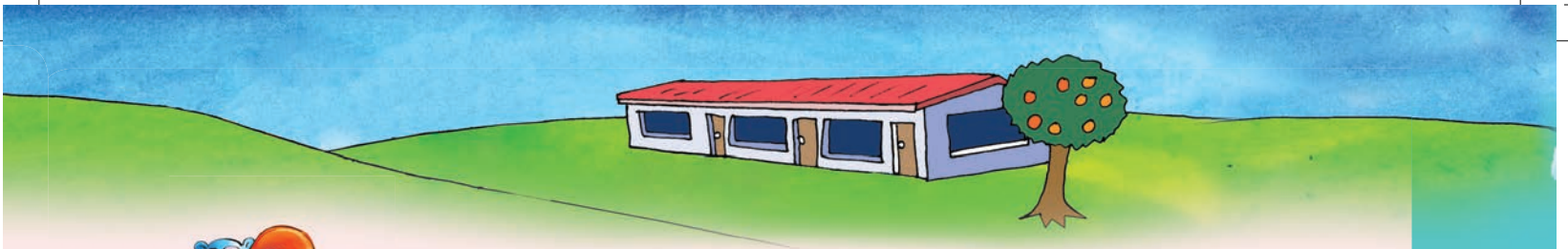



Probeer nou hierdie somme.

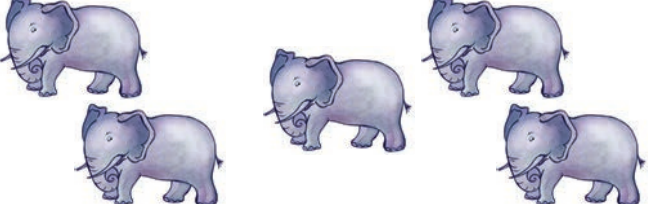

en en is



en en is



en en is

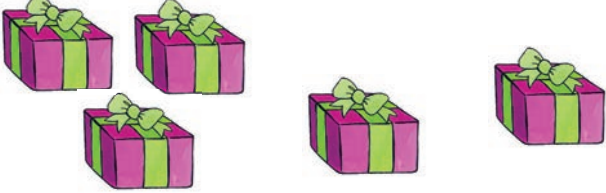

en en is



en en is



en en is



Onderwyser-handtekening:

Datum:





Verdubbeling



Verdubbel die kolletjies op die vlerke.

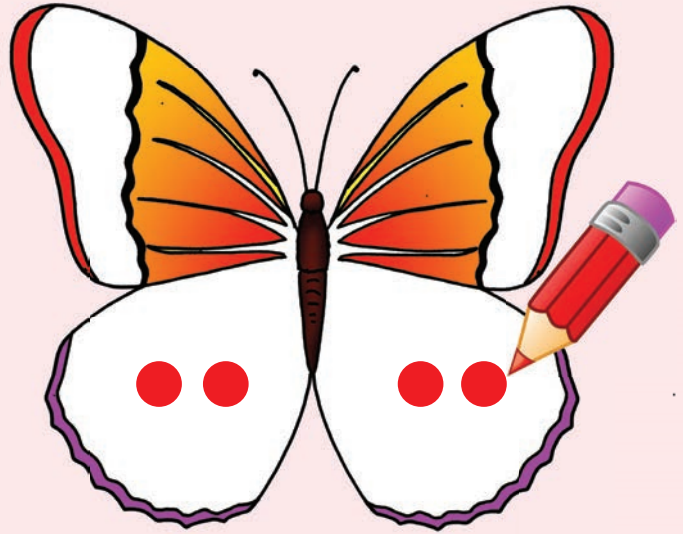
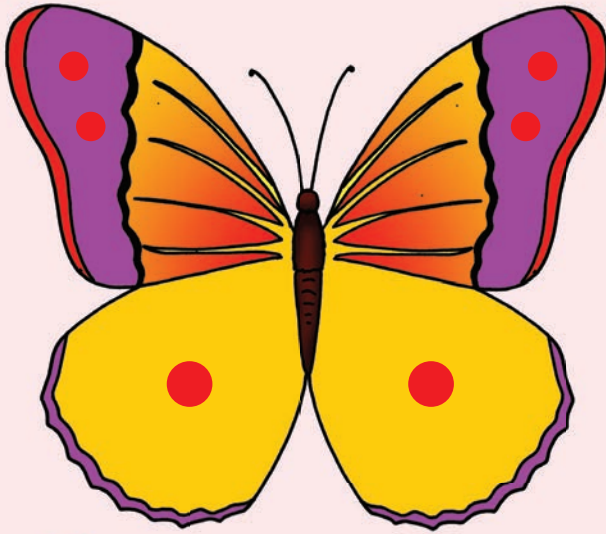

Verdubbel die vorms.

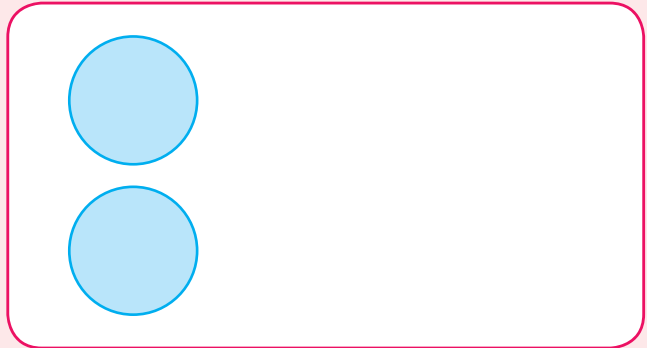
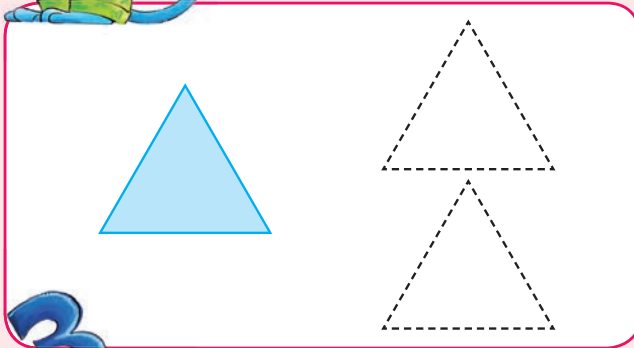

Teken en vul dan die getalle in.

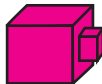
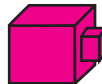
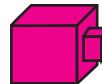

Dubbel  is   Dubbel is

Dubbel  is Dubbel is







Teken en vul dan die getalle in.

Dubbeld  is  

Dubbeld is

plus is

Dubbeld  is 

Dubbeld is

plus is



Wys die volgende op die getallelyne.

Dubbeld 1 is

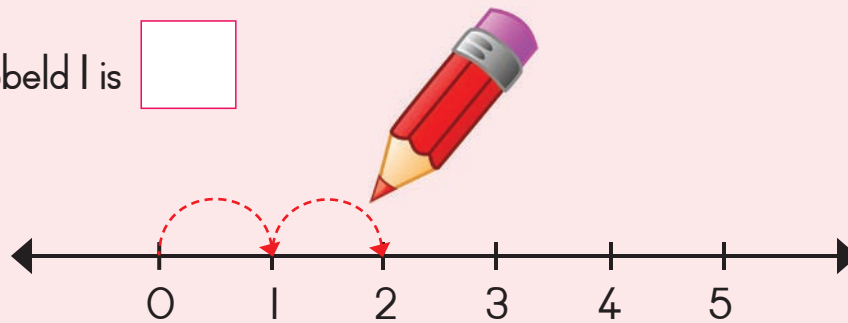

Dubbeld 2 is

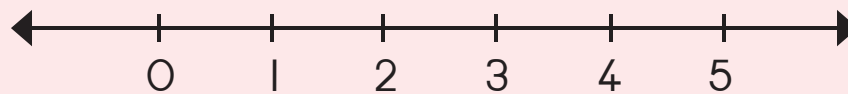

Onderwyser-handtekening:

Datum:





Groter en kleiner



- Trek 'n sirkel om die grootste dier en
- Teken 'n vierkant om die kleinste diertjie in elke raampie.

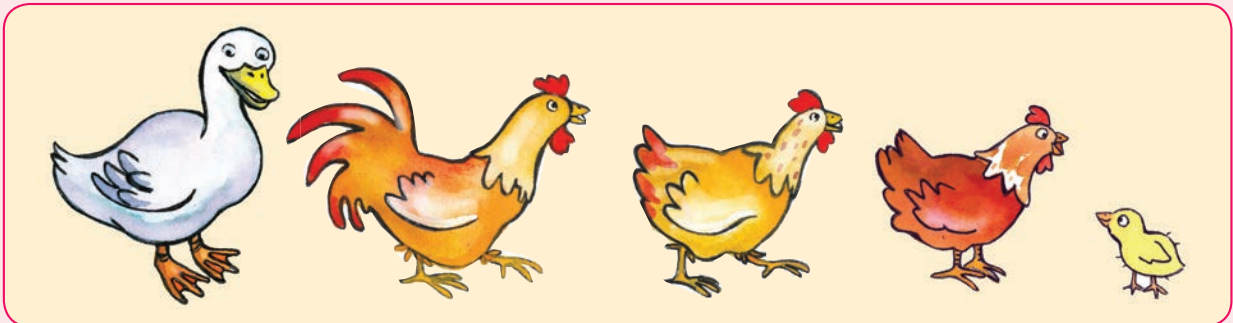
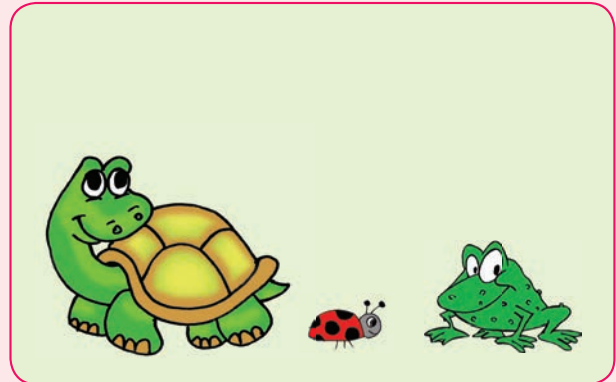
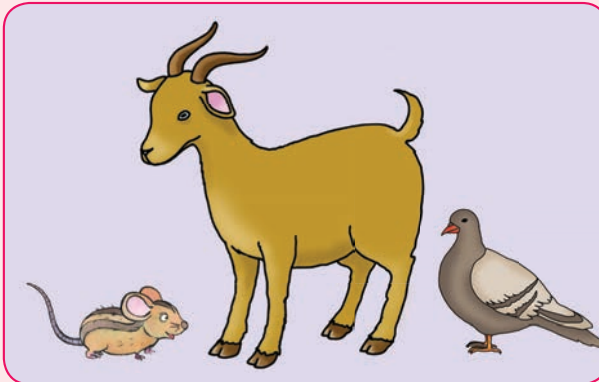
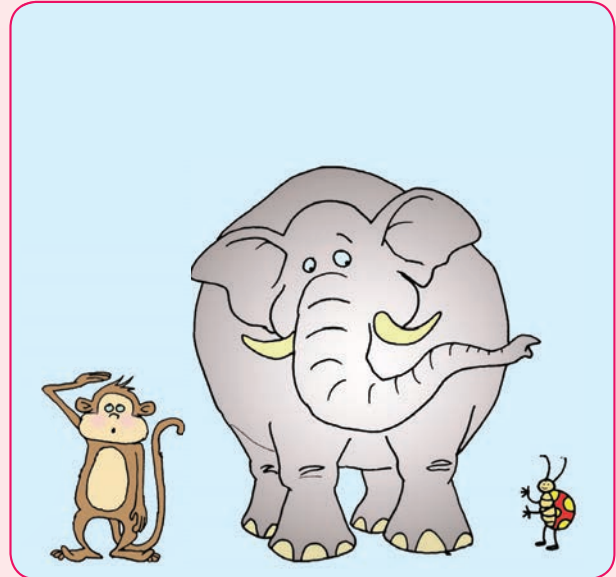
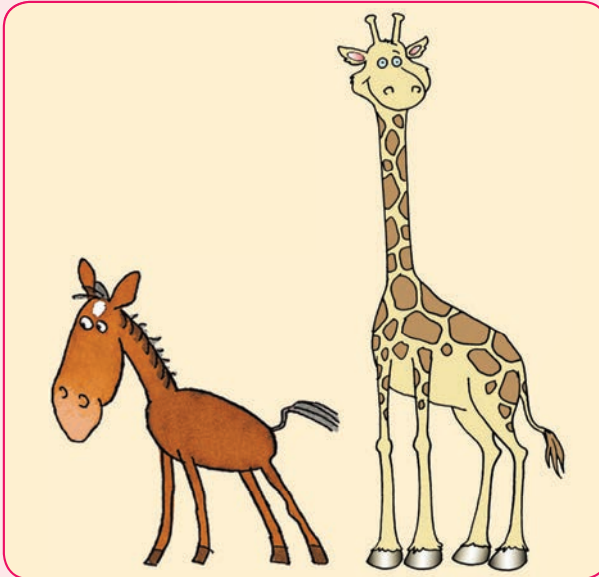

groot klein

grootste kleinste



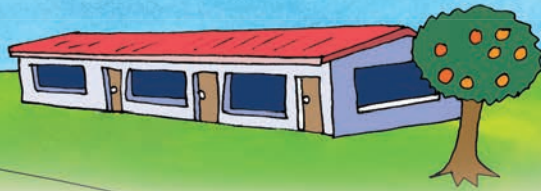

Teken 'n groter bal.

Teken 'n kleiner bal.



Teken 'n kleiner boks.

Teken 'n groter boks.

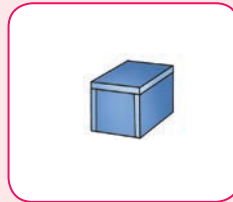
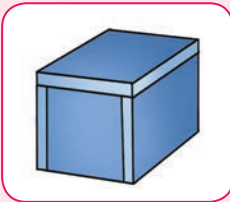

Kleur die kleinste boks en bal in.

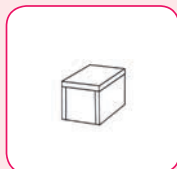
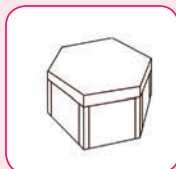
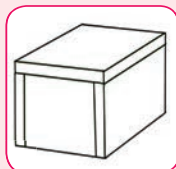
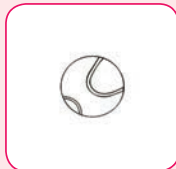

Kleur die grootste boks en bal in.

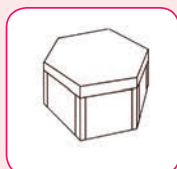
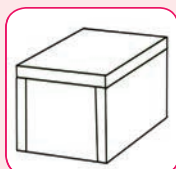
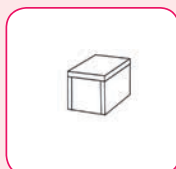

Onderwyser-
handtekening:

Datum:

Sorteer voorwerpen

Kies die gesorteerde voorwerpen wat by die prent pas.

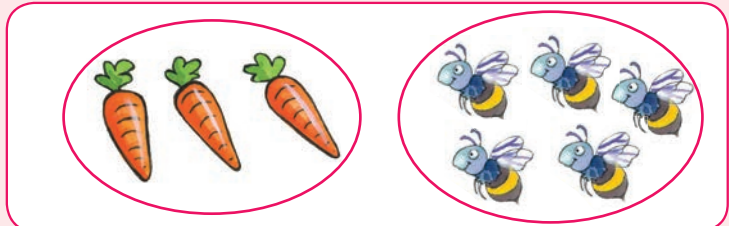
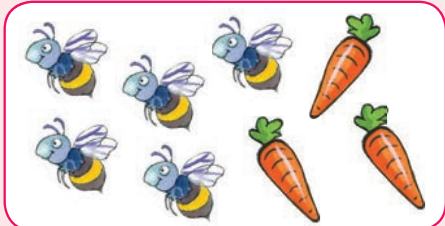

Sorteer deur 'n tekening van elkeen te maak.

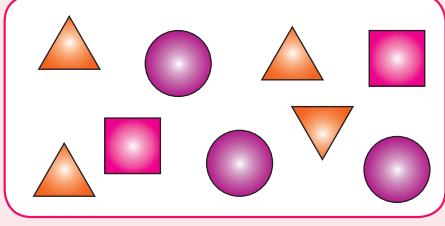
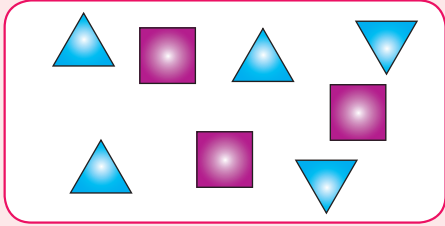
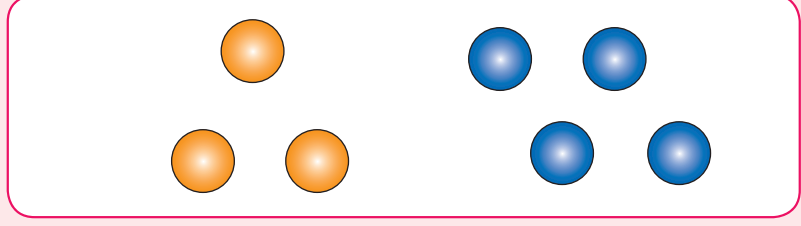
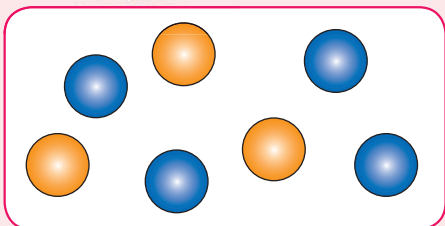

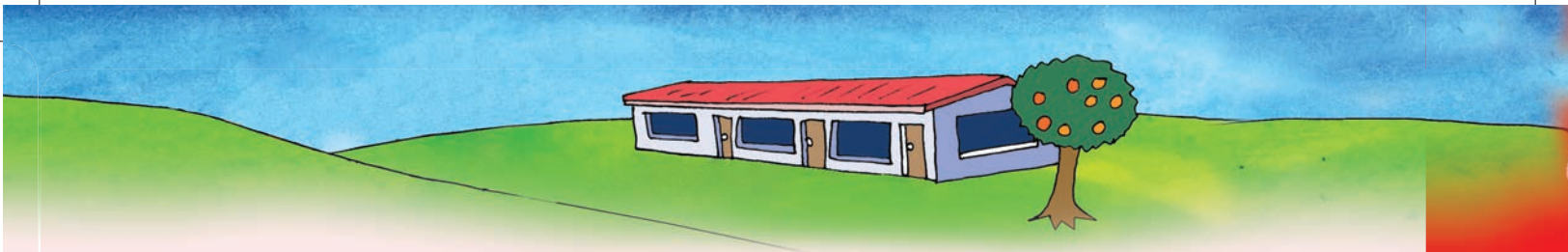

Teken die vorms in die prentgrafiek oor.
Tel nou die vorms op en skryf die getal onder in die blokkie neer.

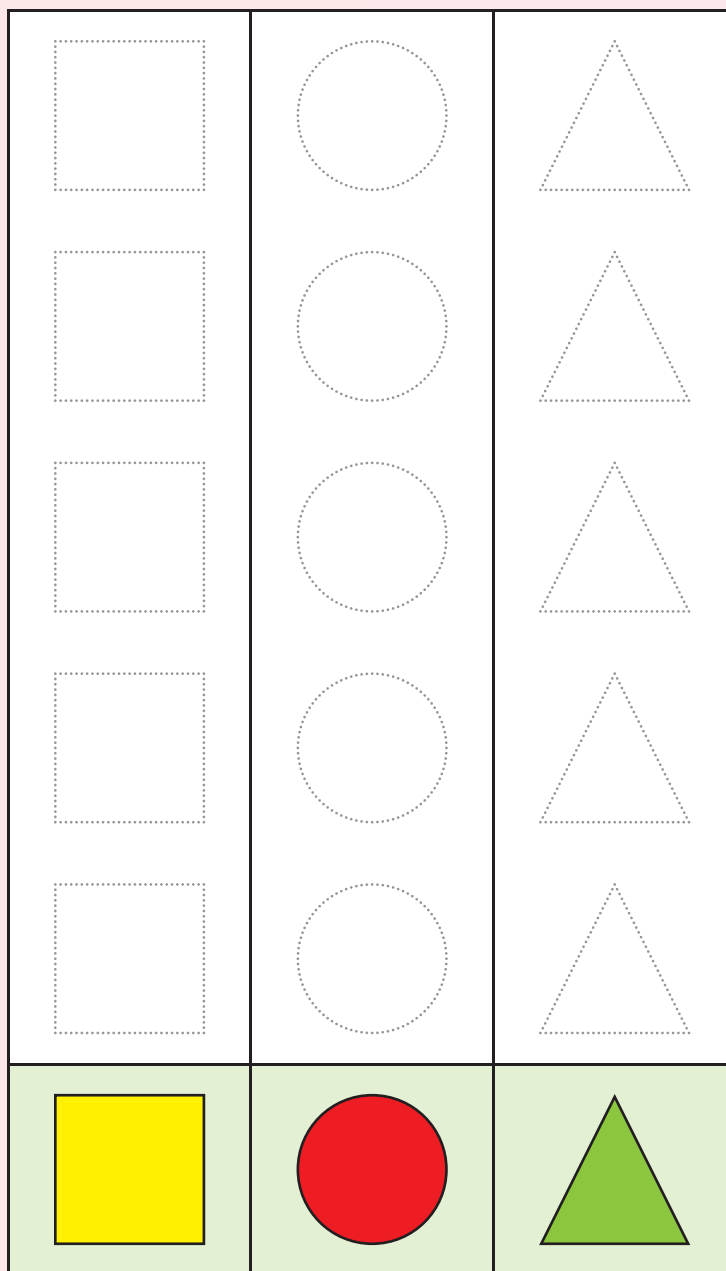
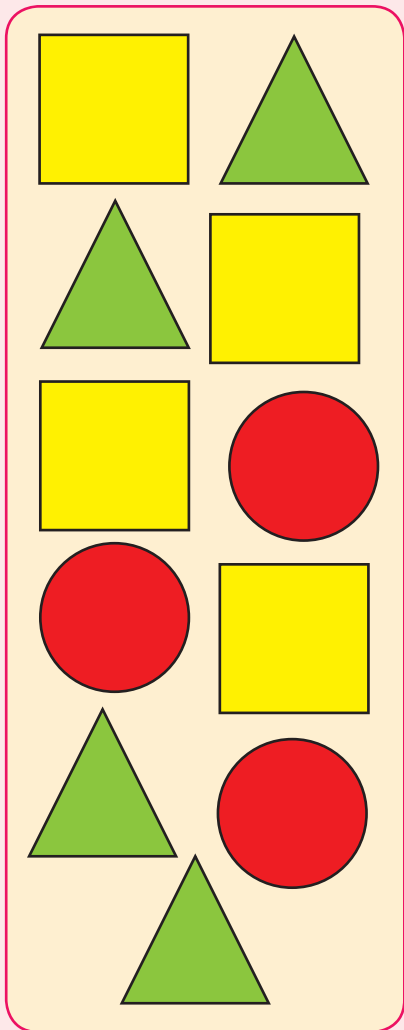

Onderwyser-
handtekening:

Datum:





Kom ons verdeel gelykop

Tel die lemoene, piesangs en appels en skryf die getal in die blokkie neer.

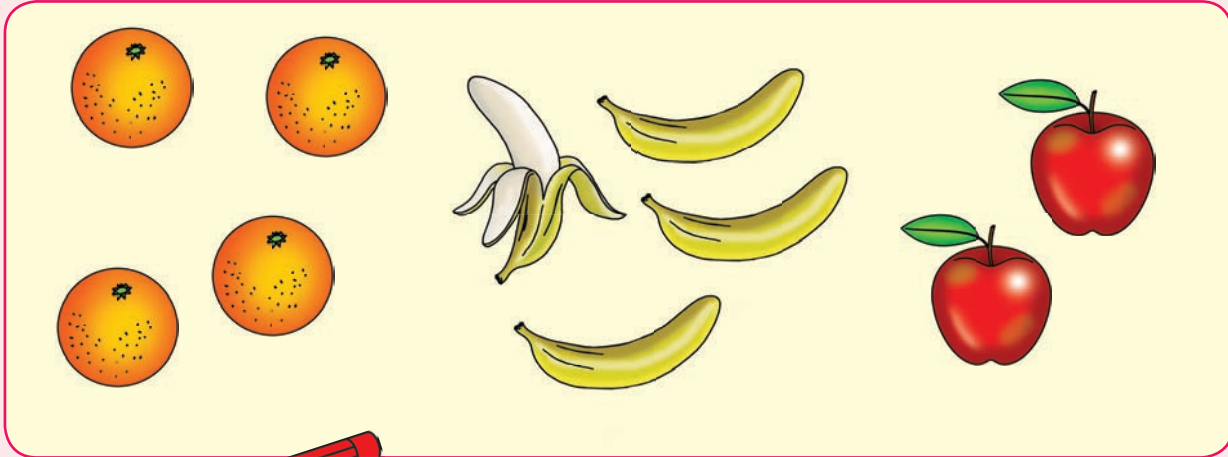

4 lemoene

piesangs

appels

Verdeel die lemoene, piesangs en appels gelykop tussen die twee kinders. Teken die vrugte wat elkeen kry in die blokkies.

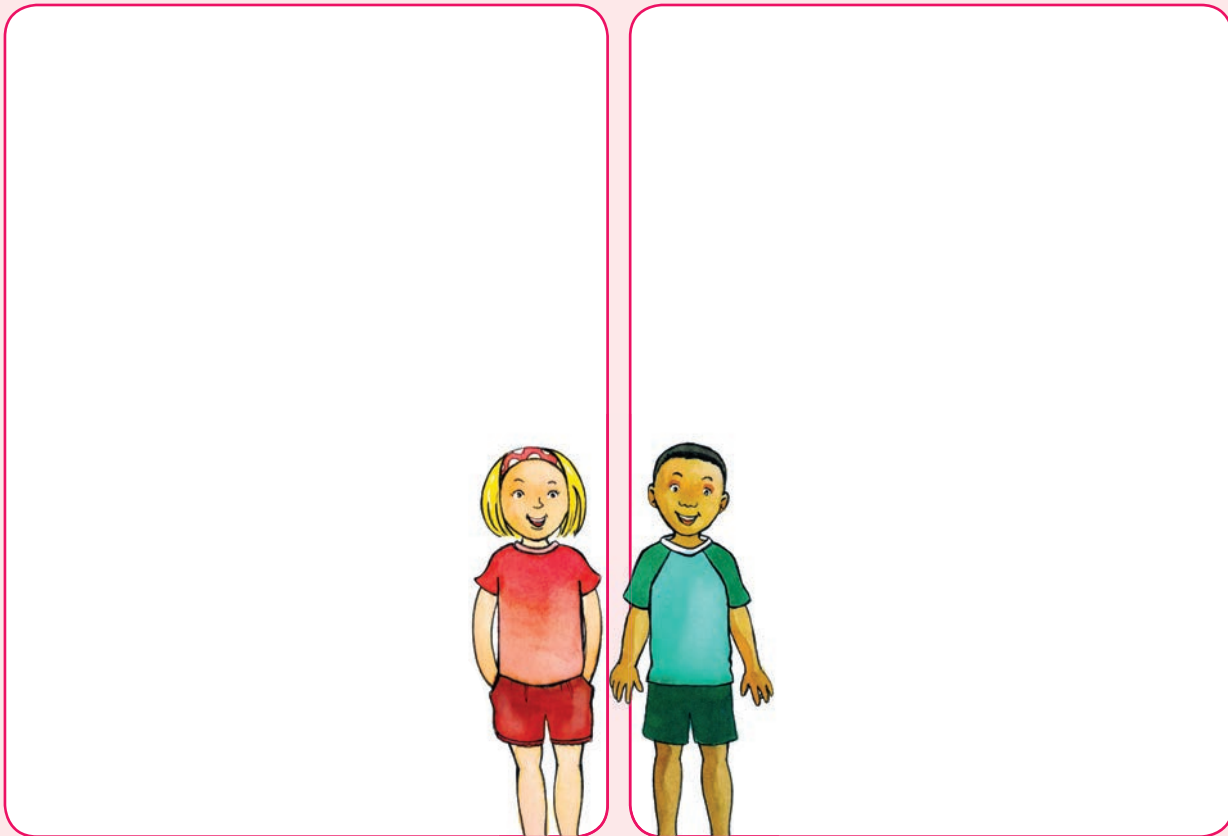

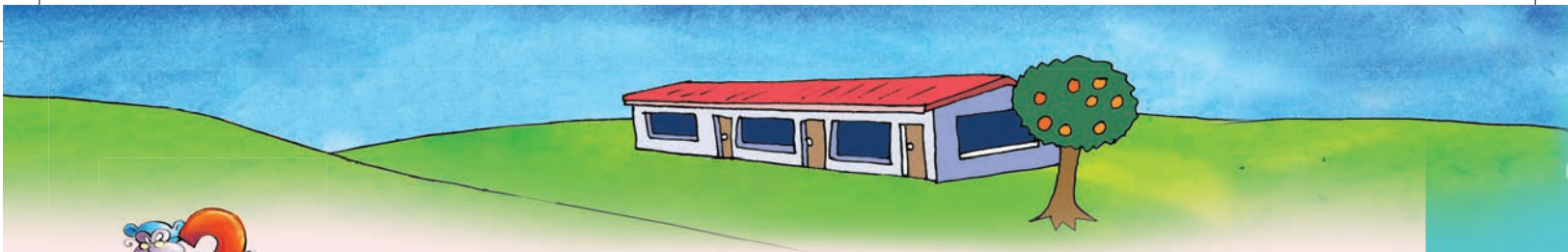

Verdeel die groep in die eerste blokkie in 2 gelyke groepe en teken elke nuwe groep in sy eie blokkie.



 4 = 2 + 2

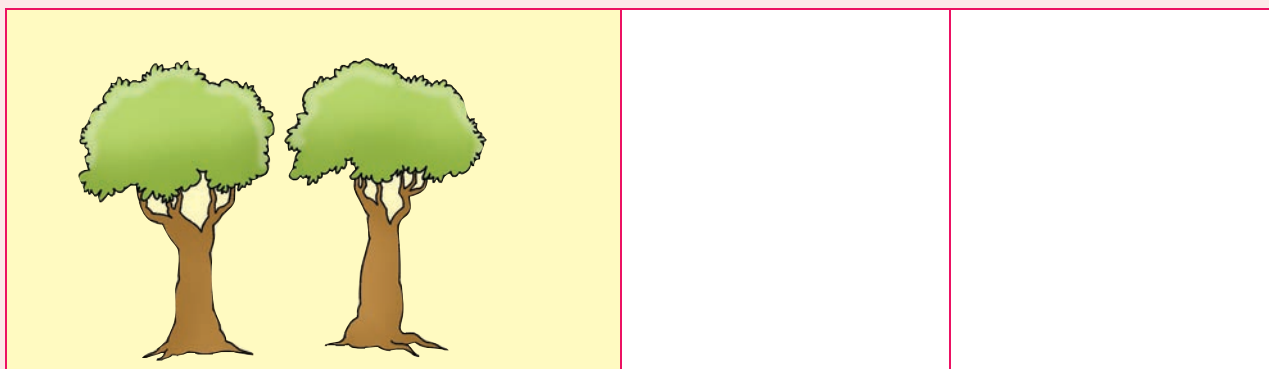

= +

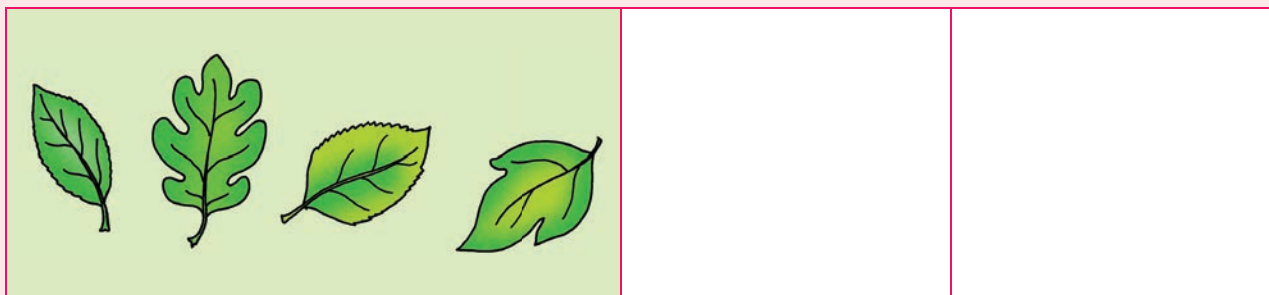

= +



Onderwyser-handtekening:

Datum:



Gelyke verdeling

Verdeel die vrugte en diere gelykop en omkring dan die groepe.

Hoeveel piesangs het elke apie gekry?

Hoeveel wortels het elke hasie gekry?

Hoeveel appels het elke apie gekry?

Het daar enige appels oorgebly nadat jy dit verdeel het?

Hoeveel wortels het elke hasie gekry?

Het daar enige wortels oorgebly nadat jy dit verdeel het?



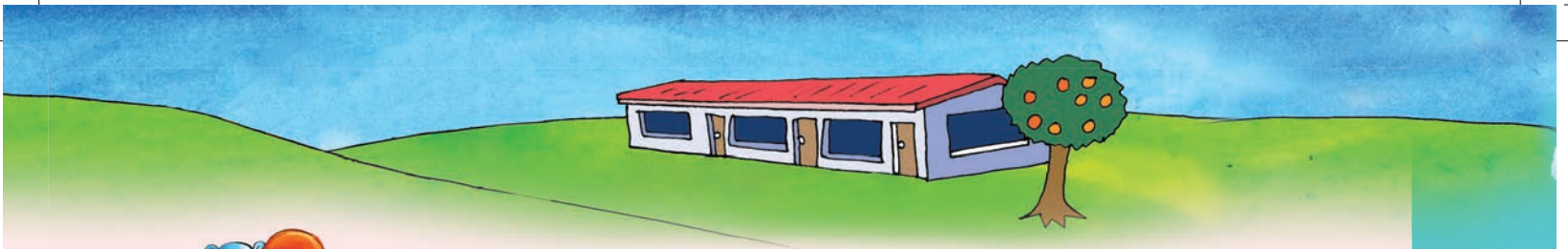

Verdeel die tellers in twee gelyke groepe en trek 'n kruis op die teller(s) wat oorbly.

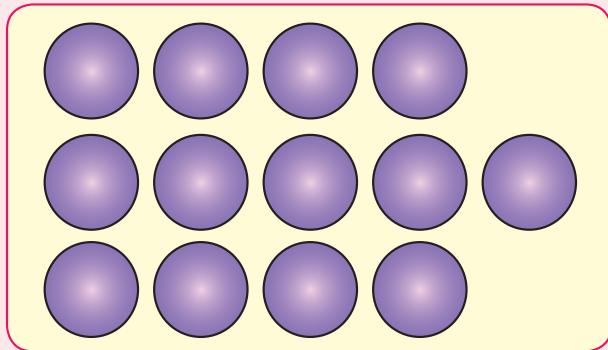
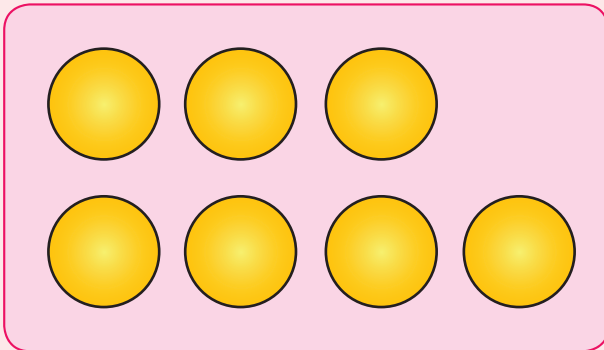
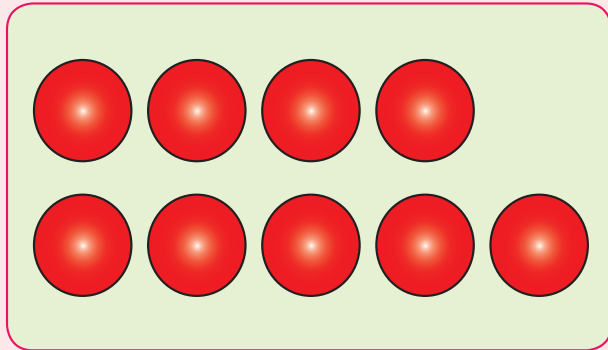
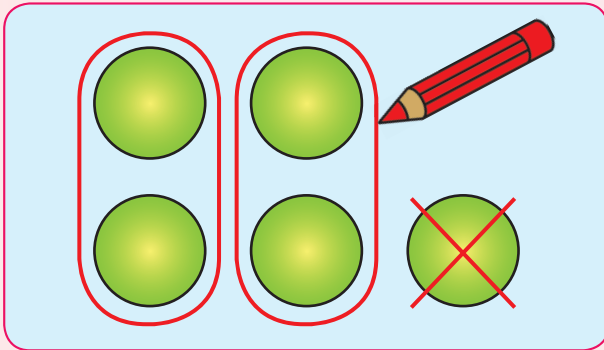

Verdeel die tellers in drie gelyke groepe en trek 'n kruis op die teller(s) wat oorbly.

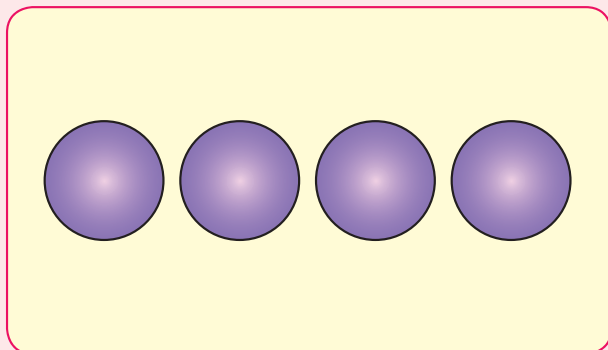
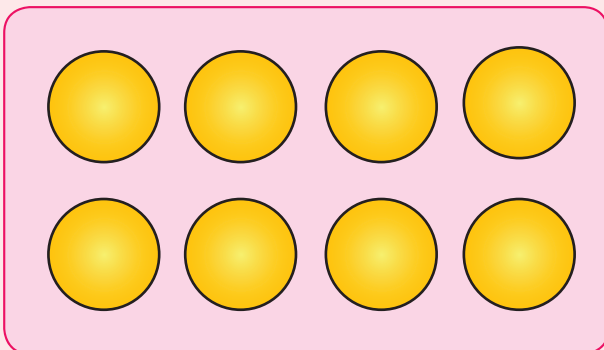
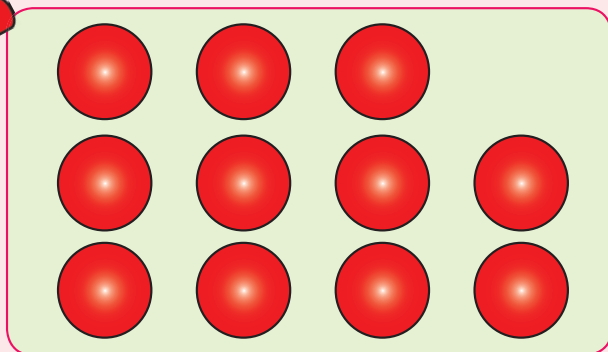
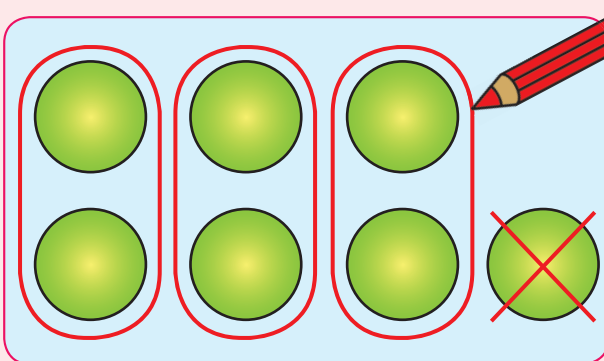

Onderwyser-handtekening:

Datum:



Kan jy 'n toring met al die voorwerpe bou?
Merk ja of nee.

Bou met voorwerpe

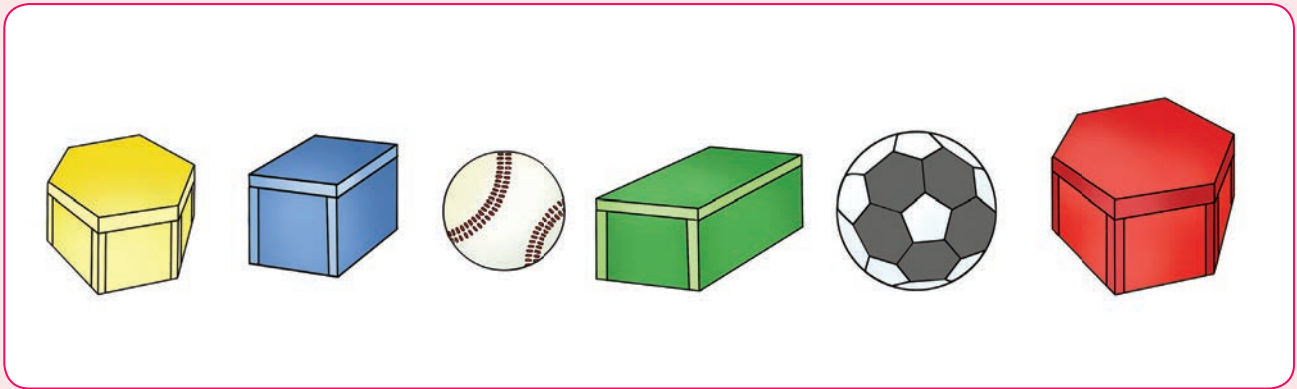

Ja

Nee

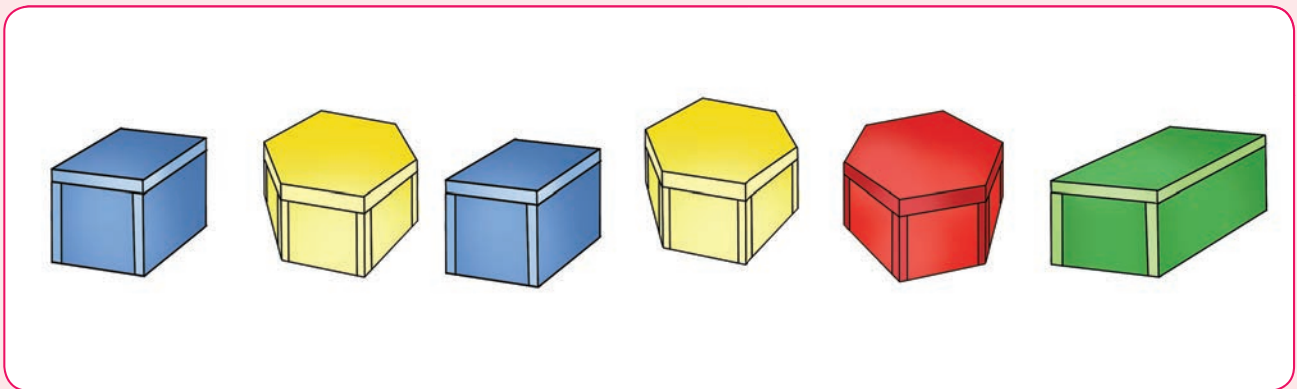

Ja

Nee



Ja

Nee

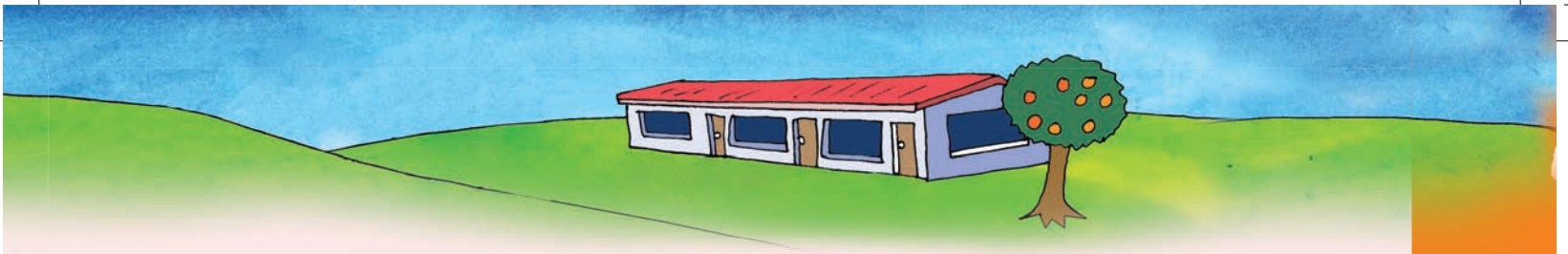

Sal die toring bly staan of nie? Maak 'n ✓ of 'n x.

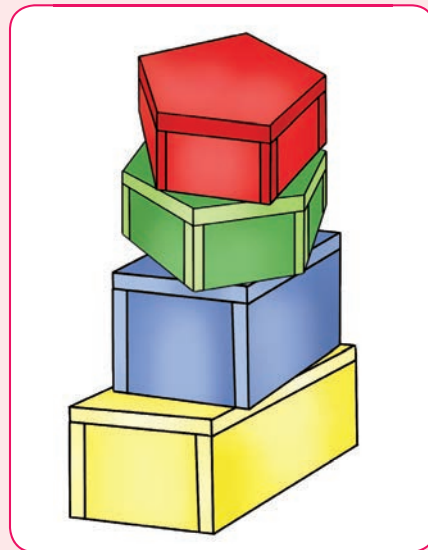
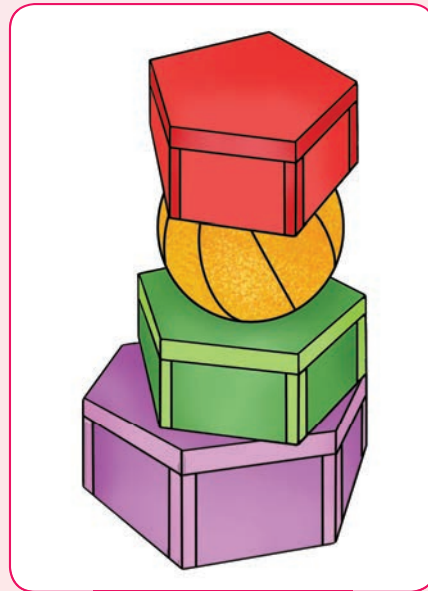
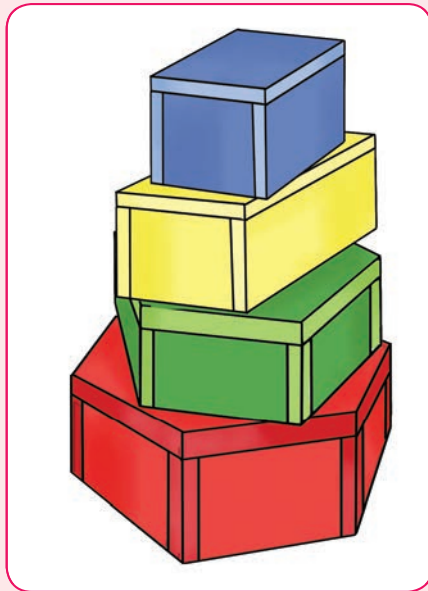

Gebruik tien vuurhoutjiesboksies en gom hulle aan mekaar vas om jou eie gebou te maak. Maak gom dit makliker?



Onderwyser-handtekening:

Datum:



Trek die maande van die jaar na.
Kleur die ballon by jou verjaardagmaand in.

Lees hoe laat dit is



Januarie

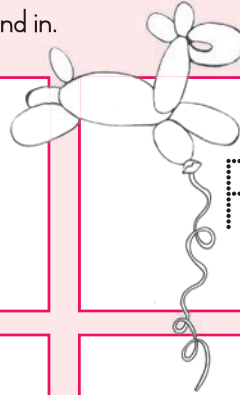

Februarie

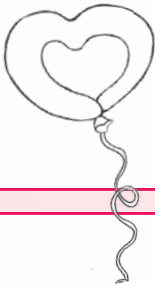

Maart

April

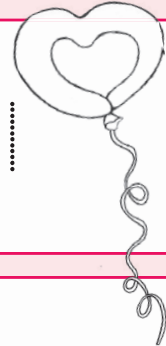

Mei

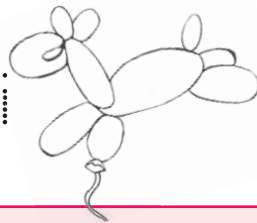

Junie



Julie

Augustus



September



Oktober

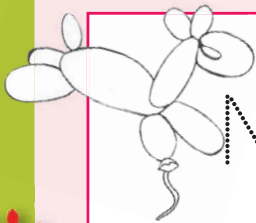

November

Desember

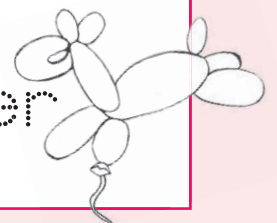



Trek die dae van die week na.
Kleur vandag se blokkie in.



Maandag



Dinsdag



Woensdag



Donderdag

Vrydag



Saterdag



Onderwyser-
handtekening:

Datum:

11 12 13 14 15 16 17 18 19 20



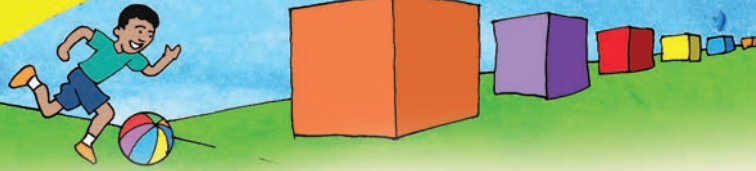

Ses



Teken 6 sirkels in die blok.

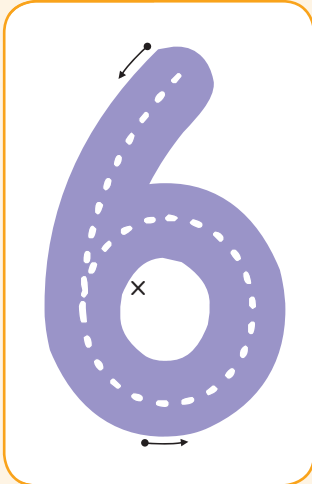

Trek die getalle na.



Verbind dieselfde prentjies met mekaar.





Kleur 6 sirkels in.

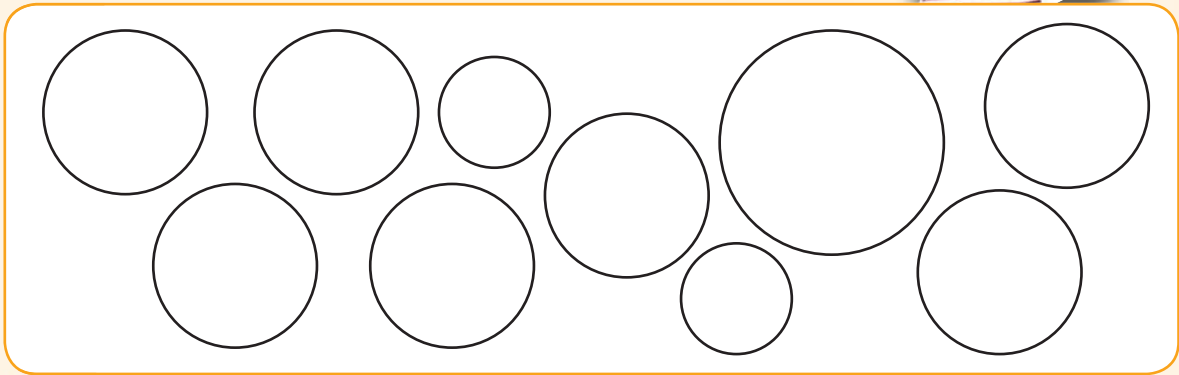

Kopieer en teken nog 6.

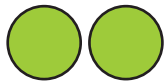

Oefen die getal.



ses



Tel die sirkels terwyl jy hulle inkleur.



Onderwyser-handtekening.

Datum:



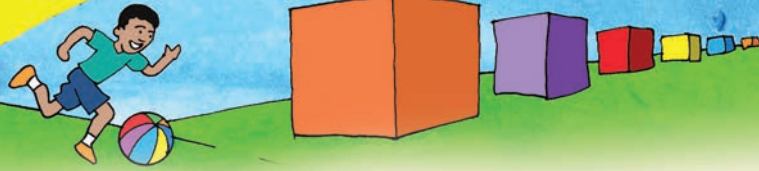

Sewe



Teken 7 vierkante in die blok.

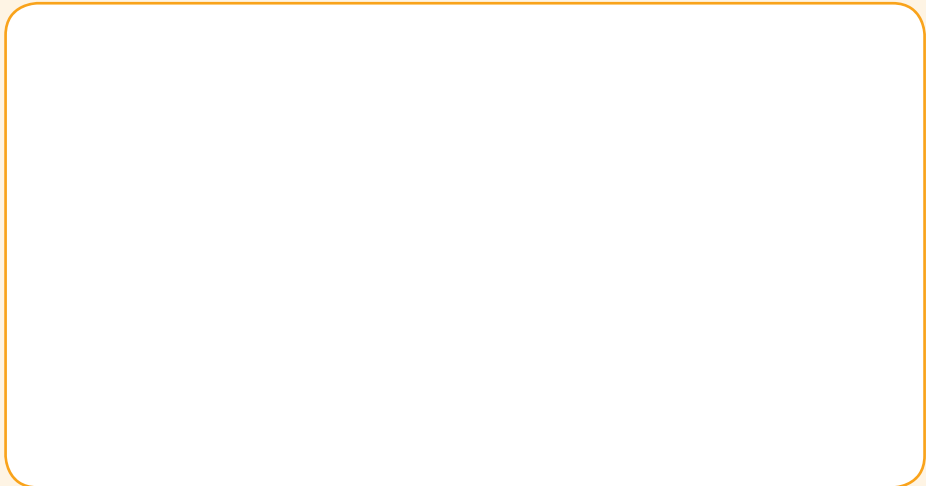

Trek die getalle na.



Verbind dieselfde prentjies met mekaar.

7 7 7 7 7 7 7

7 7 7 7 7 7 7

7 7 7 7 7 7 7

7 7 7 7 7 7 7

7 7 7 7 7 7 7

7 7 7 7 7 7 7

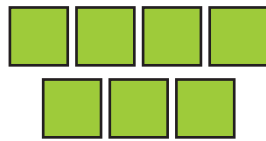

sewe

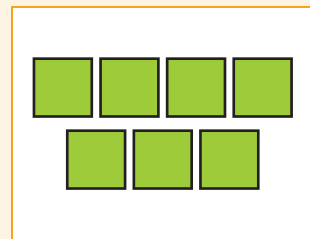

sewe



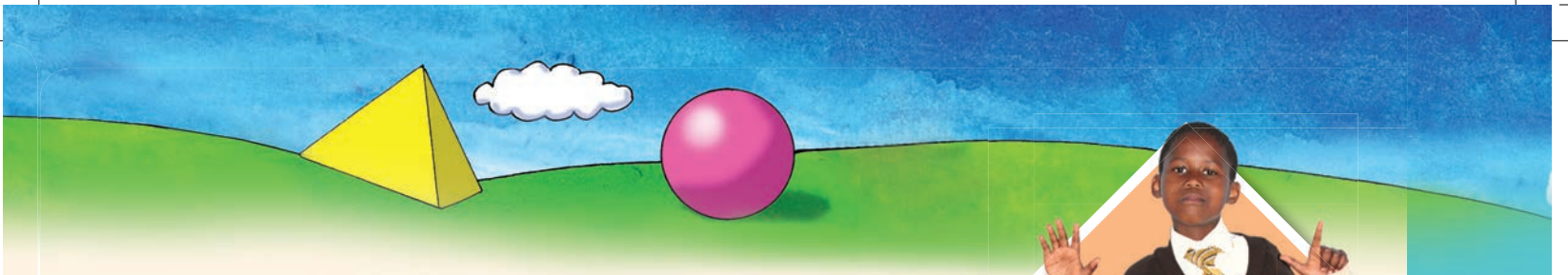

Kleur 7 reghoeke en blokkies in.

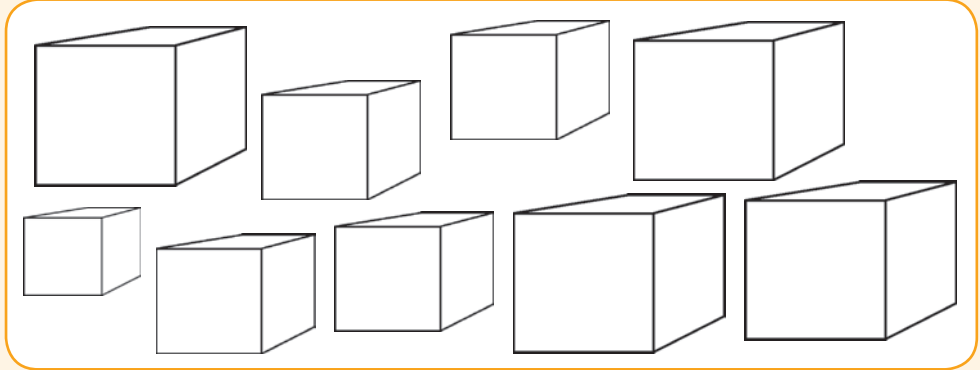
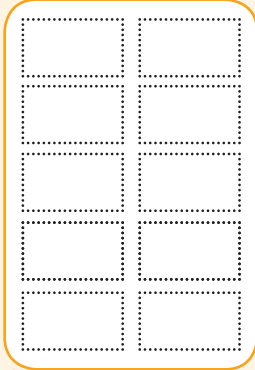

Kopieer en teken nog 7.

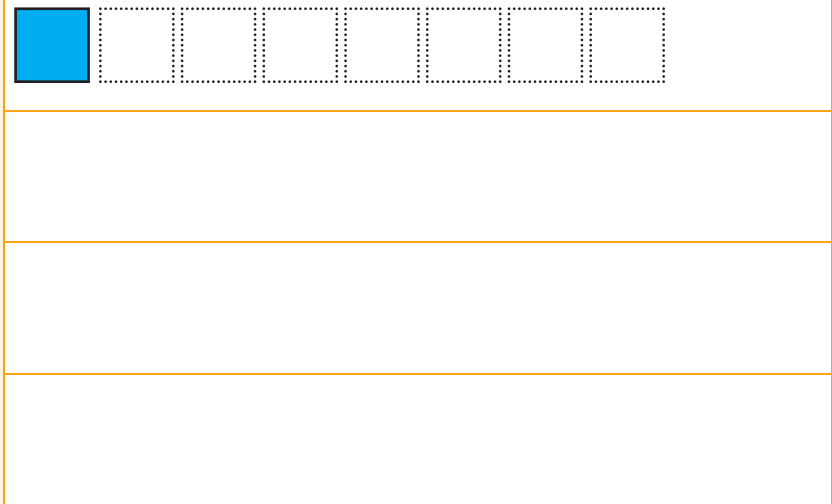
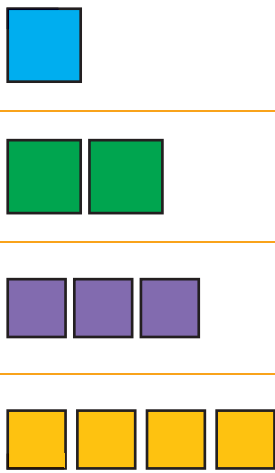

Oefen die getal.

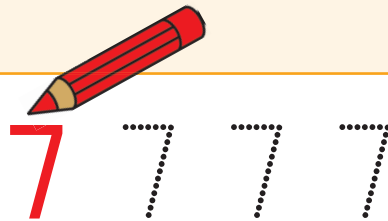

Tel die vierkante terwyl jy hulle inkleur.

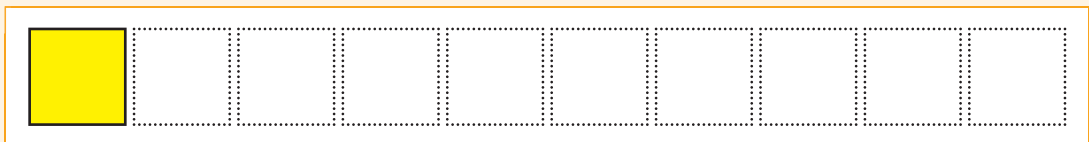

Onderwyser-handtekening:

Datum:



Agt



Teken 8 vorms in die blok.

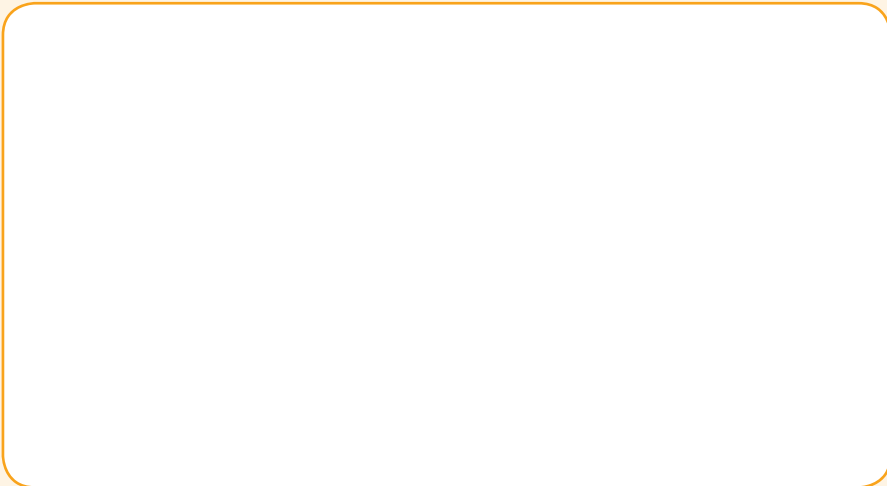
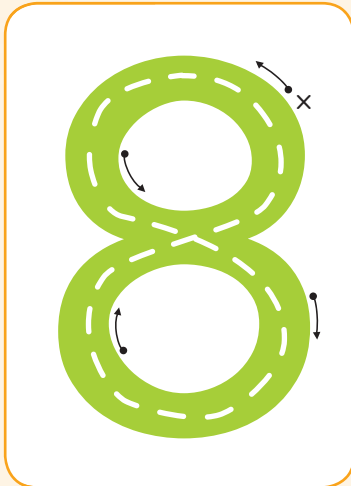

Trek die getalle na.



Verbind dieselfde prentjies met mekaar.





Kleur 8 sterre in.



Kopieer en teken nog 8.



Oefen die getal.



aght



Tel die sirkels terwyl jy hulle inkleur.

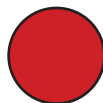

Onderwyser-handtekening.

Datum:

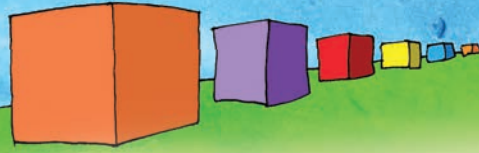

Nege



Teken 9 harte in die blok.

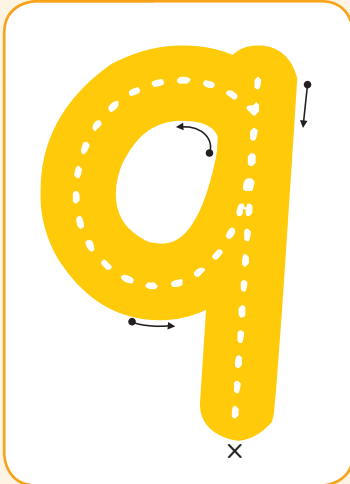

Trek die getalle na.



Verbind dieselfde prentjies met mekaar.

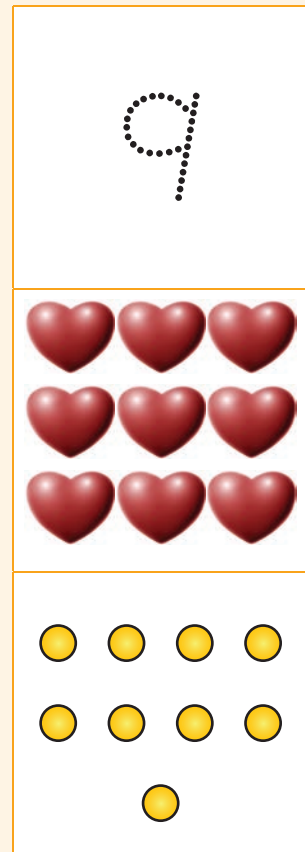
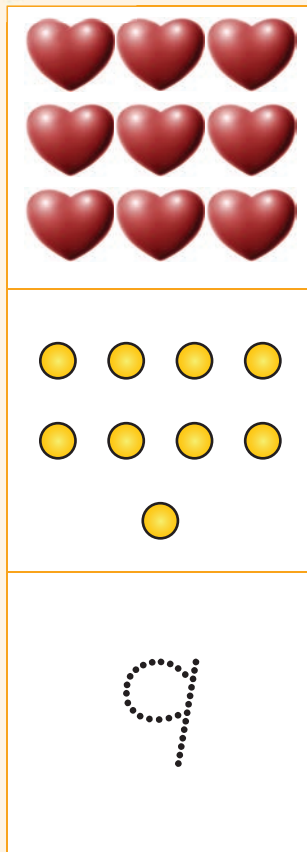
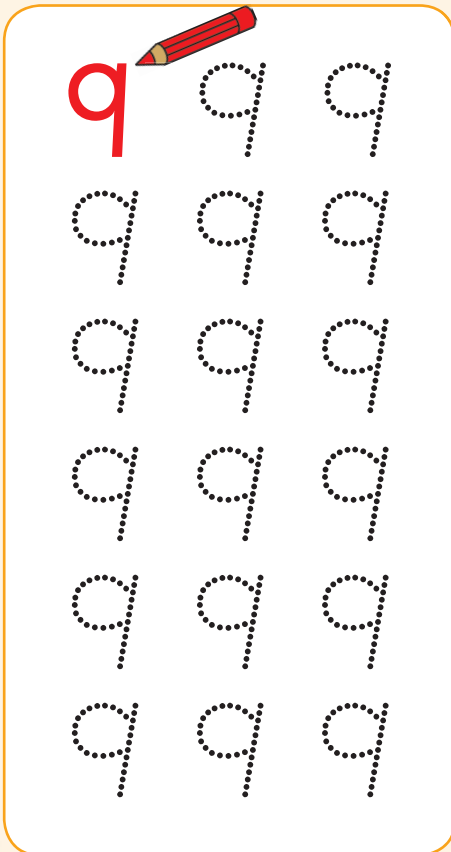



Kleur 9 ballonne in.

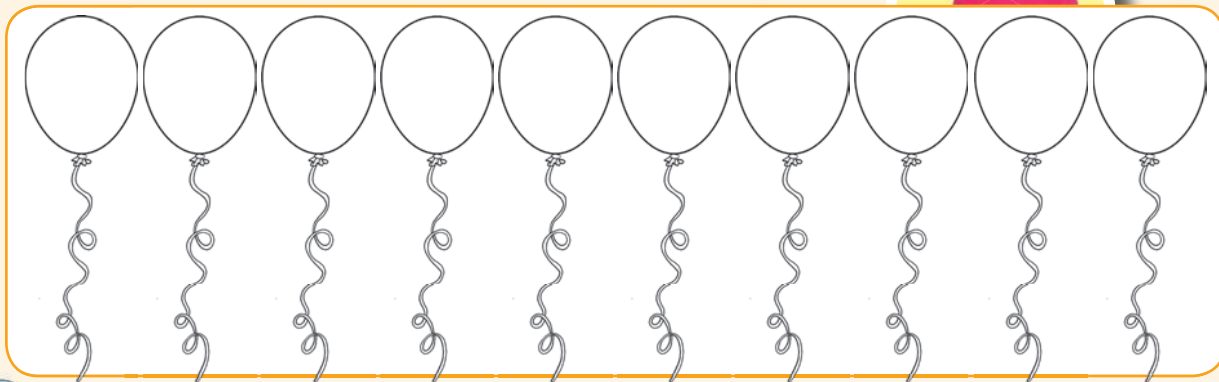

Kopieer en teken nog 9.

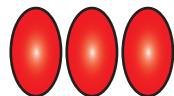

Oefen die getal.



nege



Tel die driehoeke terwyl jy hulle inkleur.

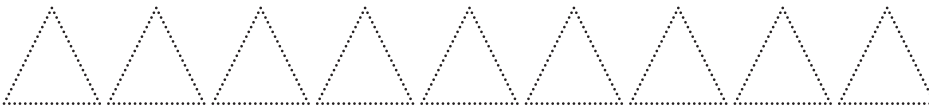

Onderwyser-handtekening:

Datum:

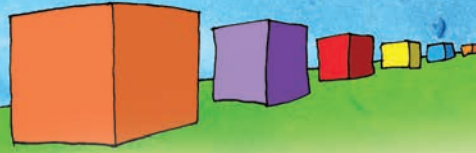

Vol en leeg



Kies die regte antwoorde en kleur dit in.
Is die houters vol of leeg?



leeg vol leeg vol

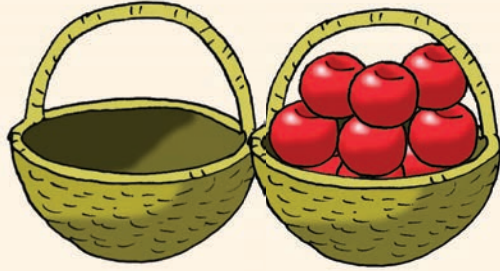

leeg vol leeg vol

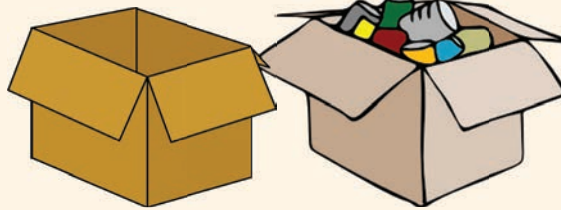

leeg vol leeg vol

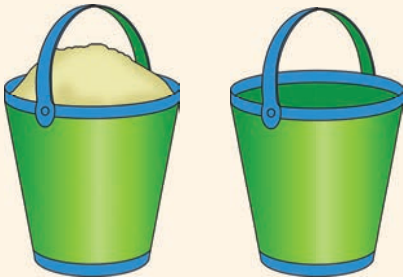

leeg vol leeg vol

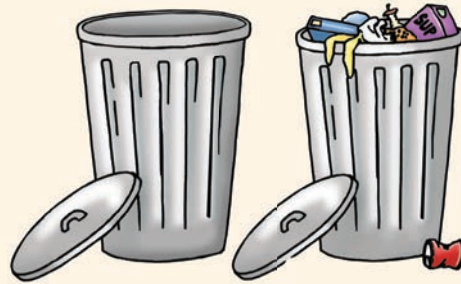

leeg vol leeg vol



leeg vol leeg vol



leeg vol leeg vol

leeg vol





Kleur die regte antwoord in.
Is die houters vol of leeg?

leeg vol

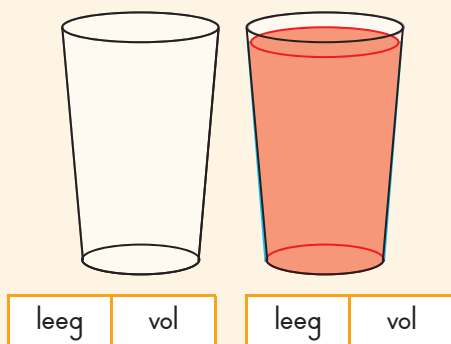
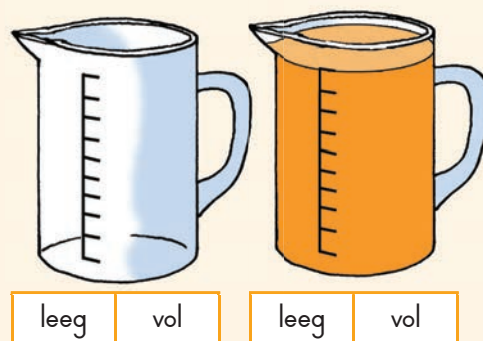
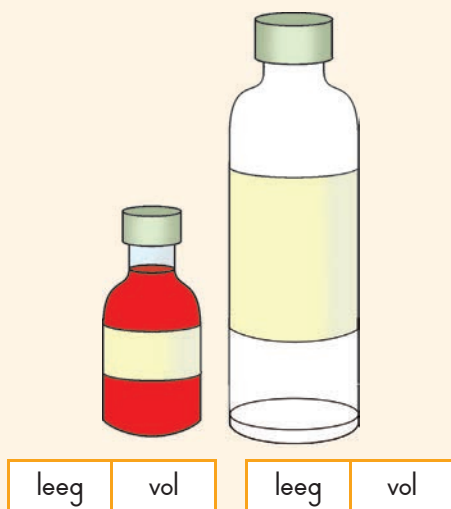
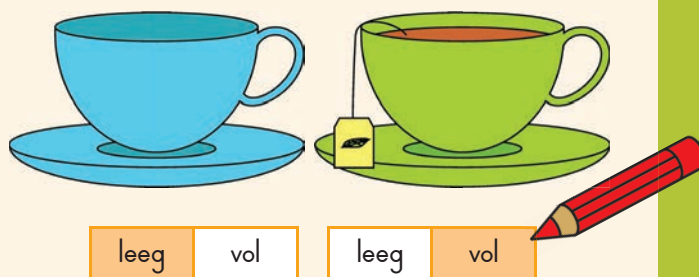

Onderwyser-
handtekening:

Datum:

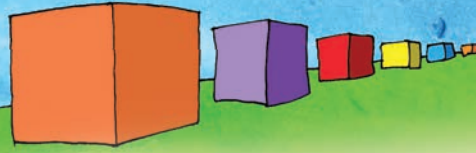

Tien



Tel al jou vingers.

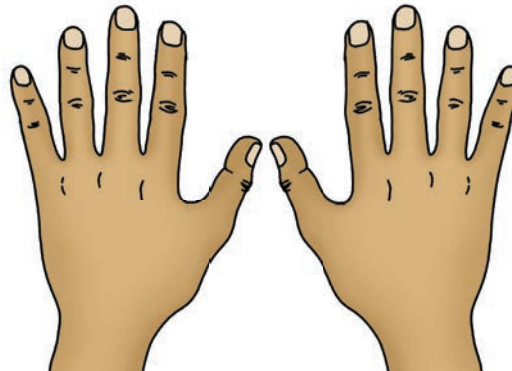
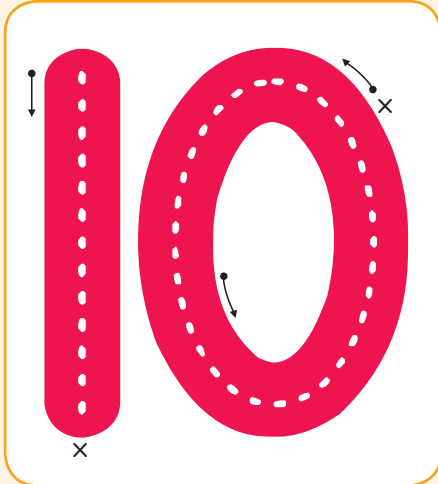

Trek die getalle na.

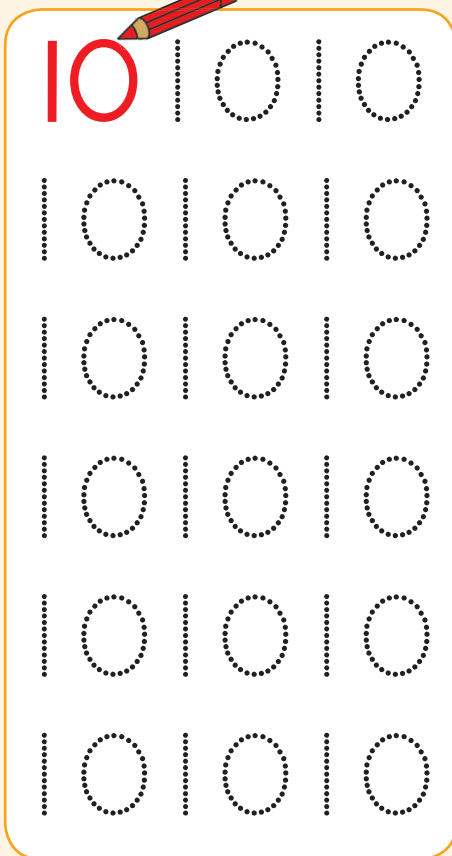

Verbind dieselfde prentjies met mekaar.

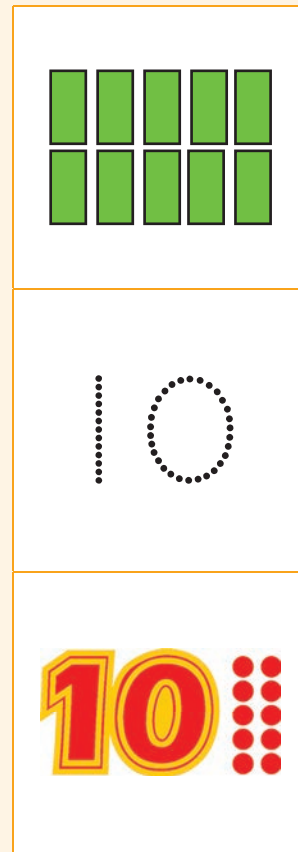
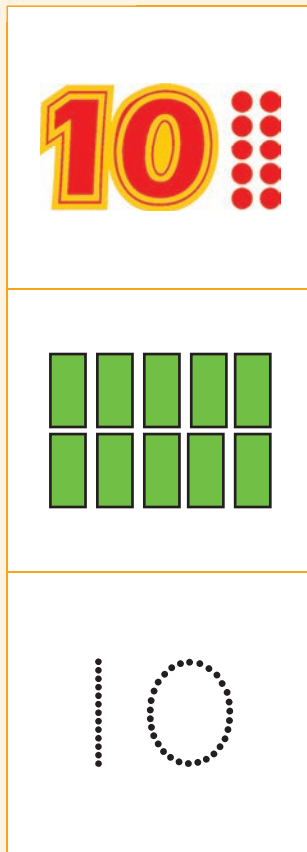



Kleur 10 vrugte in.

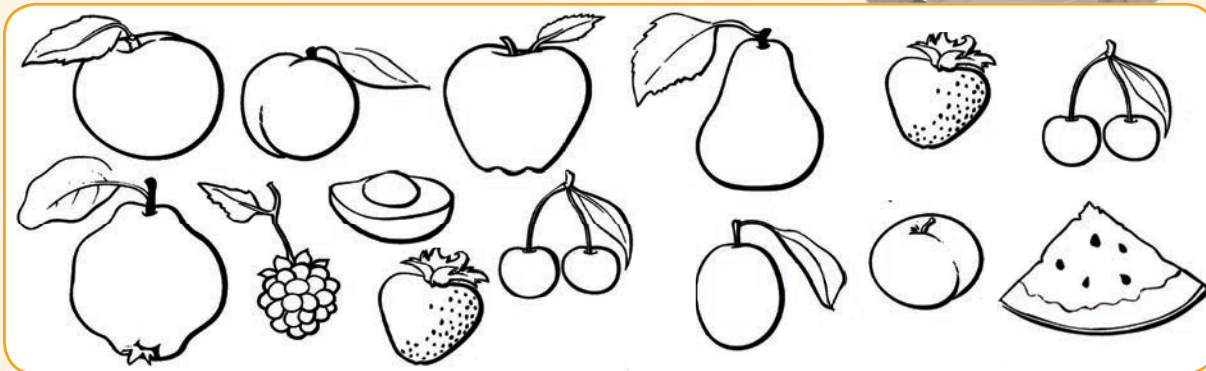

Kopieer en teken nog 10.



Oefen die getal.



tien



Tel die reghoeke terwyl jy hulle inkleur.





Onderwyser-handtekening:

Datum:



Nommer van 1 tot 10

Gebruik jou vingers om te wys hoeveel dit is. Skryf die getalle dan neer.

	1	1
	2	2
	3	3
	4	4
	5	5
	6	6
	7	7
	8	8
	9	9
	10	10



Getalle van 6 tot 10



Oefen om hierdie getalle te skryf.



6

ses



6 6 6 6



7

sewe

7 7



8

aght

8 8



9

nege

9 9



10

tien

10 10



Onderwyser-handtekening:

Datum:

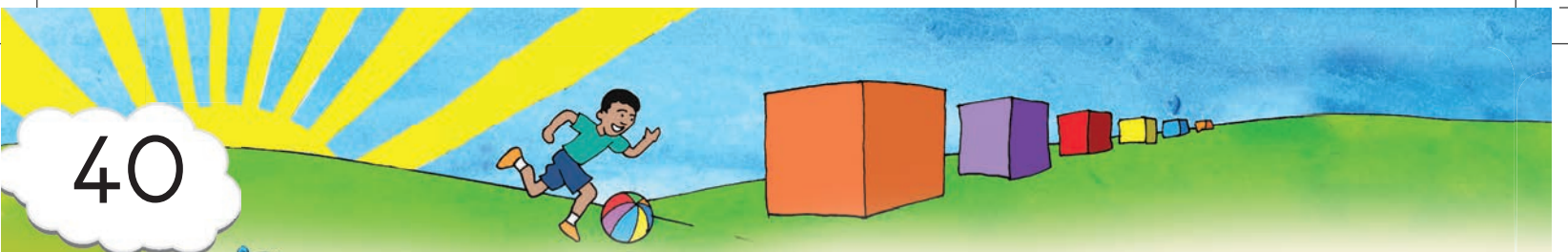

Inhoudsmaat en volume



Voeg nog water by die houer aan die regterkant.

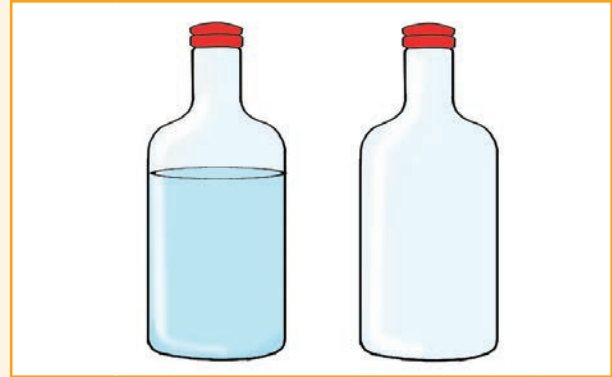
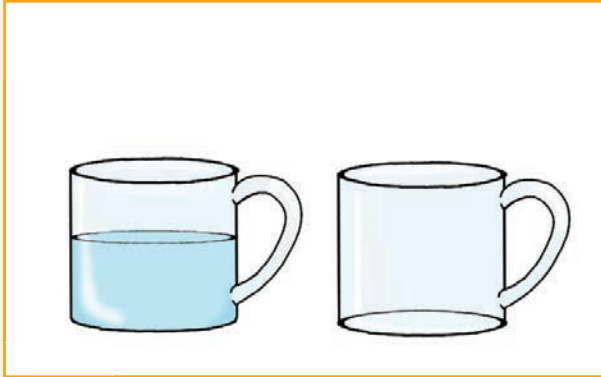

Merk watter houer meer water het.

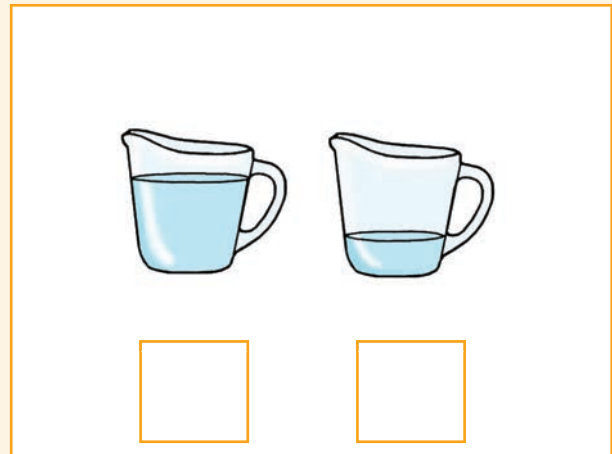
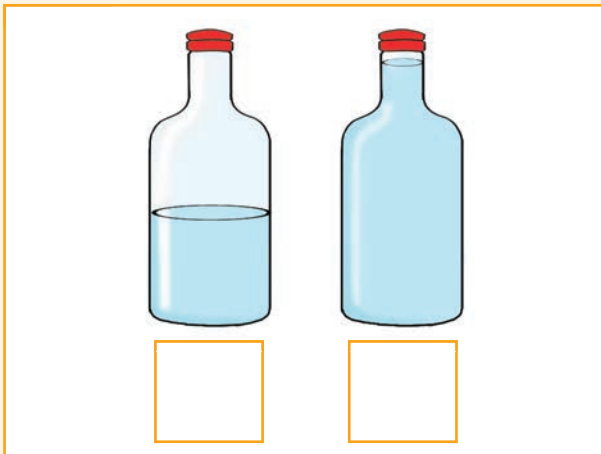

Merk watter houer minder water het.

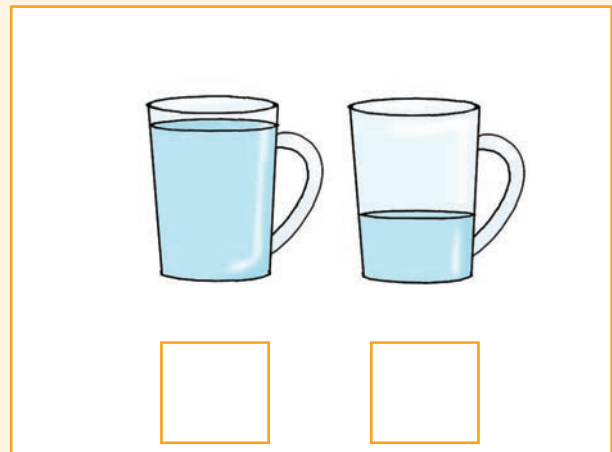
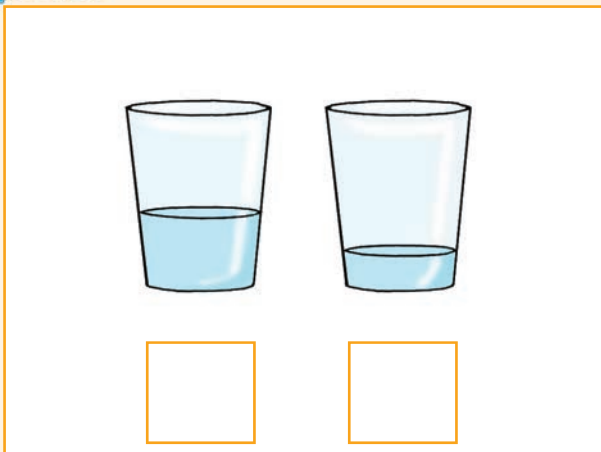



Kleur die tweede glas in om te wys dat daar minder sap in is.

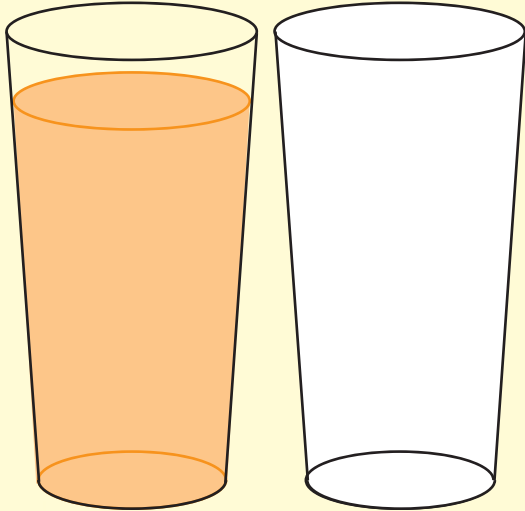

Kleur die tweede glas in om te wys dat daar meer sap in is.

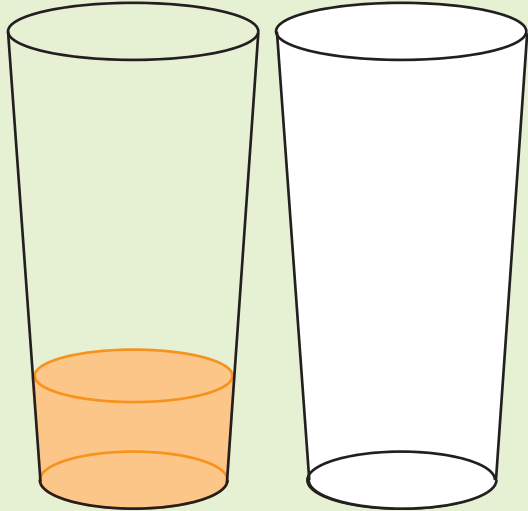

Omkring **meer as**, **minder as** en **dieselfde as**.



Die **blou** glas het

meer
as

minder
as

dieselfde
as

die **rooi** glas.

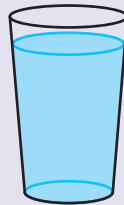
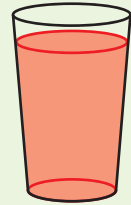

Die **blou** glas het

meer
as

minder
as

dieselfde
as

die **rooi** glas.

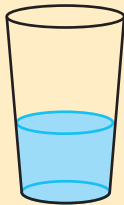
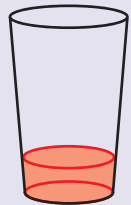

Die **blou** glas het

meer
as

minder
as

dieselfde
as

die **rooi** glas.



meer as

minder as



Onderwyser-
handtekening:

Datum:

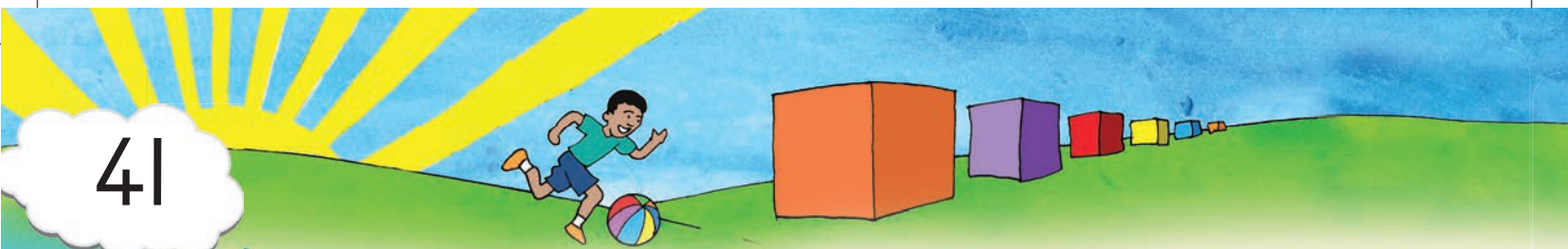

Getalle van 1 tot 10



Omkring in elke blok die groepie met die minste vorms.

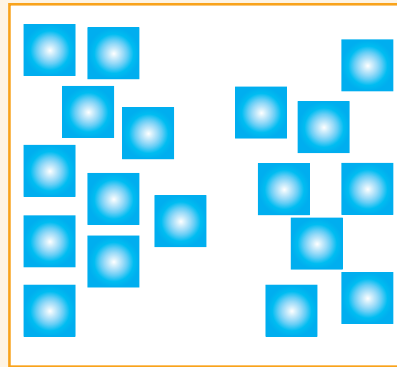
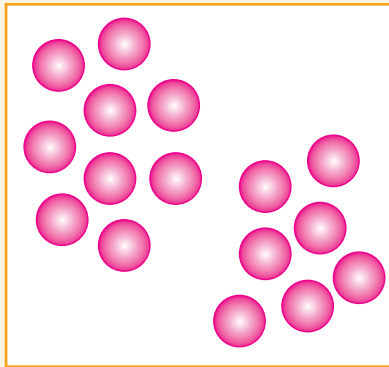
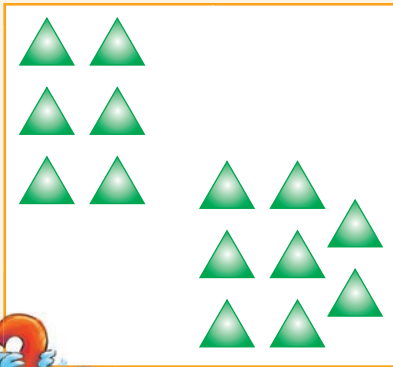

Skryf die getalle van die kleinste tot die grootste op die getallelyn.

2 4 3
6 1 5

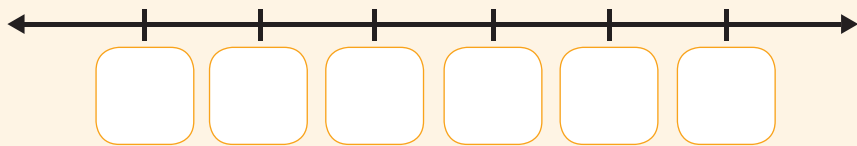

4 6 8
7 9 5

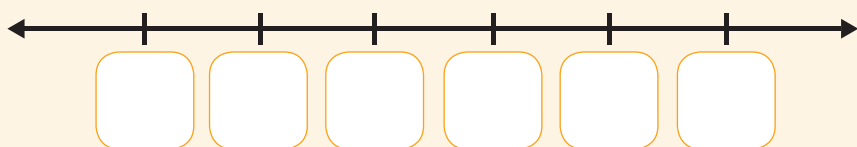

Kleur die kleinste getal groen en die grootste getal oranje in.

7 4 3

9 10 8

5 1 6

4 6 2



Los die volgende op. Jy kan tekeninge maak om jou te help.

Een meer as 5.

Twee meer as 5.

Een minder as 6.

Twee minder as 7.



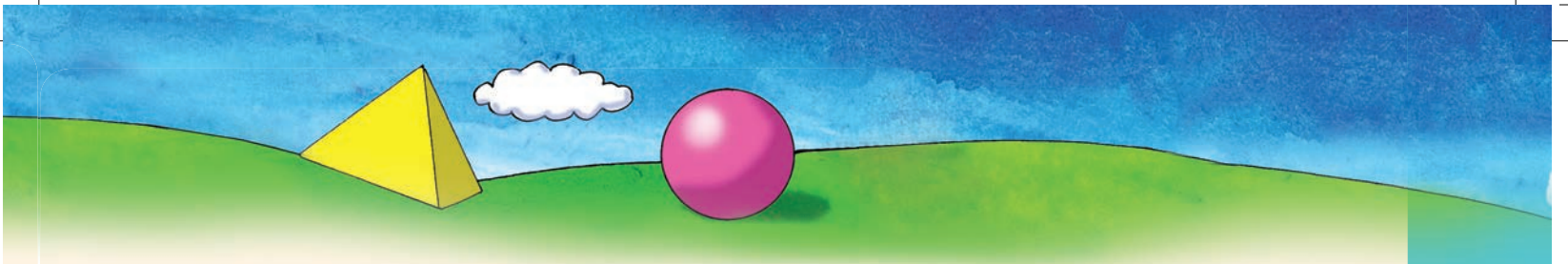

Kralelyn



Vul die getalle in wat weggelaat is.

10 rows of bead strings for a number line activity. Each row has 10 beads on a black line. A red pencil is pointing to the first bead of the first row.

- Row 1: 1 (white), 2 (blue), 3 (blue), 4 (blue), 5 (blue), 6 (blue), 7 (blue), 8 (blue), 9 (blue), 10 (blue)
- Row 2: 1 (green), 2 (green), 3 (green), (white), 5 (green), 6 (green), 7 (green), 8 (green), 9 (green), 10 (green)
- Row 3: 1 (purple), 2 (purple), 3 (purple), (white), (white), 6 (purple), 7 (purple), 8 (purple), 9 (purple), 10 (purple)
- Row 4: 1 (red), 2 (red), (white), 4 (red), 5 (red), 6 (red), (white), 8 (red), (white), 10 (red)
- Row 5: 1 (purple), 2 (purple), 3 (purple), (white), 5 (purple), 6 (purple), 7 (purple), (white), (white), 10 (purple)
- Row 6: (white), 2 (pink), (white), 4 (pink), 5 (pink), (white), 7 (pink), 8 (pink), (white), 10 (pink)
- Row 7: 1 (green), (white), 3 (green), 4 (green), 5 (green), 6 (green), 7 (green), (white), 9 (green), (white)
- Row 8: (white), (white), (white), (white), (white), (white), (white), (white), (white), (white)
- Row 9: 10 (blue), 9 (blue), 8 (blue), 7 (blue), 6 (blue), 5 (blue), (white), (white), (white), (white)



Onderwyser-
handtekening:

Datum:





Meer, net zoveel en minder

Vergelyk die voorwerpe links met die voorwerpe regs.
Kleur die korrekte antwoord in.



meer

net zoveel

minder

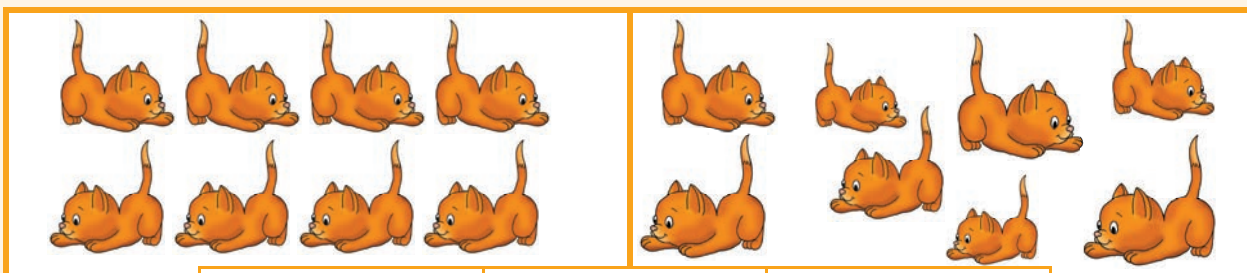

meer

net zoveel

minder



meer

net zoveel

minder

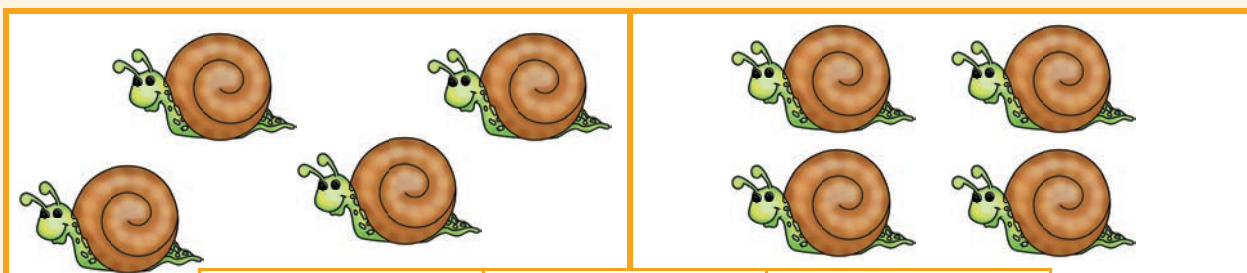

meer

net zoveel

minder





Sê of die tweede blok meer as, minder as of gelyk aan die eerste blok is.
Kleur die korrekte antwoord in.

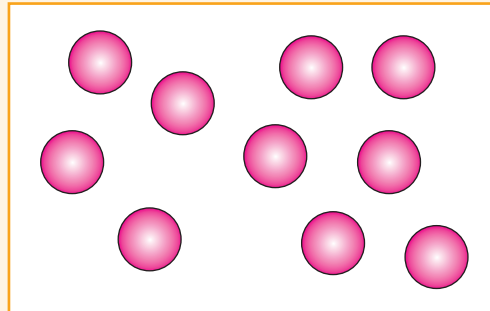
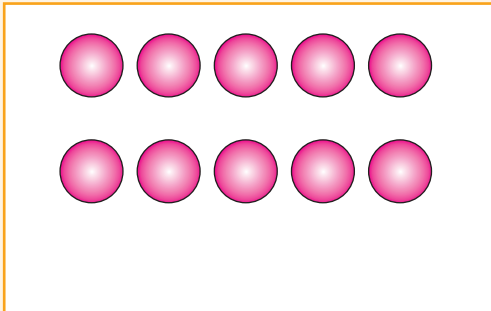

- meer as
- minder as
- gelyk aan

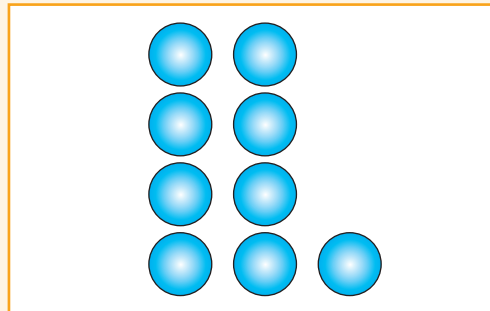
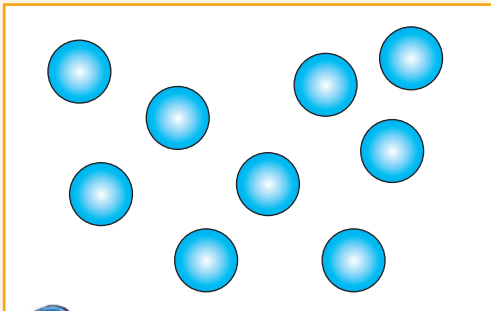

- meer as
- minder as
- gelyk aan



Kies die krale wat by die getal pas.

- 1
- 2
- 3
- 4
- 5
- 6
- 7
- 8
- 9
- 10

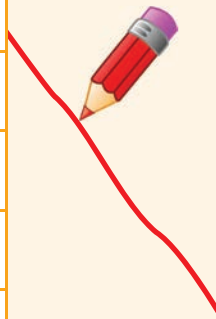

1	● ● ● ● ● ●
2	● ●
3	● ● ● ●
4	● ● ● ● ● ● ● ●
5	●
6	● ● ● ● ● ● ●
7	● ● ● ● ● ● ● ● ●
8	● ● ●
9	● ● ● ● ●
10	● ● ● ● ● ● ● ● ● ●



Onderwyser-
handtekening:
Datum:



Tel die lekkers op

Tel die lekkers op en skryf dan die antwoord neer.

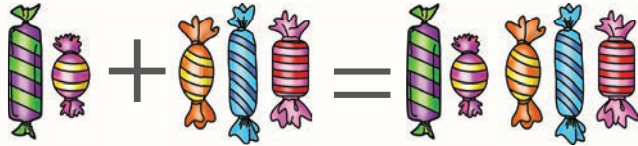

$$2 + 3 = 5$$

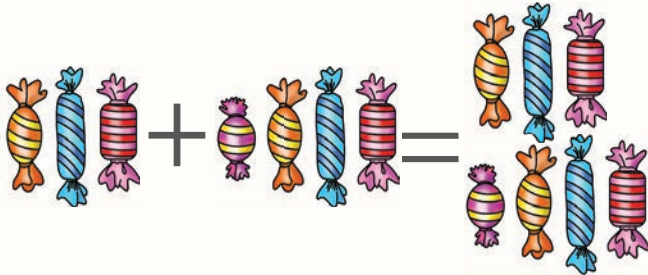

$$3 + 4 =$$



Tel op.

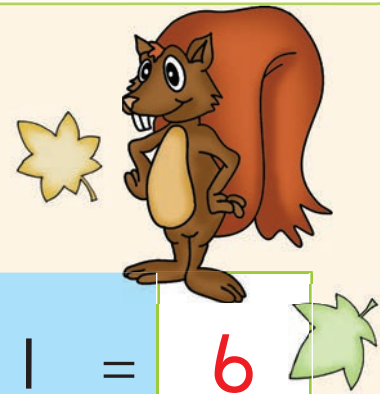

$$5 + 1 = 6$$



$$5 + 0 =$$



$$3 + 2 =$$



$$4 + 3 =$$



Probeer om die onderstaande somme te doen.

$3 + 6 = 9$

$4 + 0 = 4$

$0 + 5 = 5$

$6 + 0 =$

$2 + 2 =$

$1 + 3 =$

$2 + 5 =$

$5 + 0 =$

$1 + 8 =$

$4 + 2 =$

$1 + 1 =$

$0 + 7 =$

$3 + 2 =$

$5 + 3 =$

$7 + 2 =$

$4 + 4 =$

$5 + 1 =$

$4 + 3 =$

$2 + 6 =$

$8 + 2 =$



Onderwyser-
handtekening:

Datum:



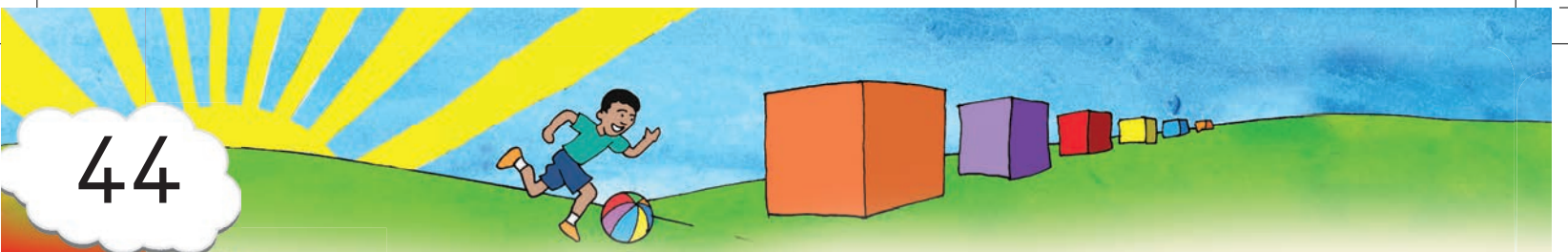

Versamel en organiseer

Sorteer en maak 'n tekening van die versamelings wat jy gesorteer het.

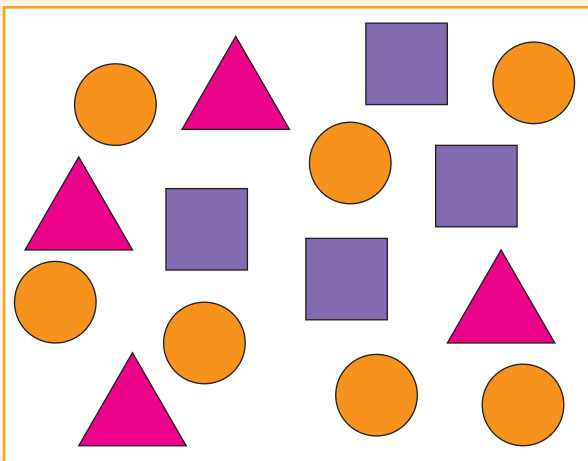
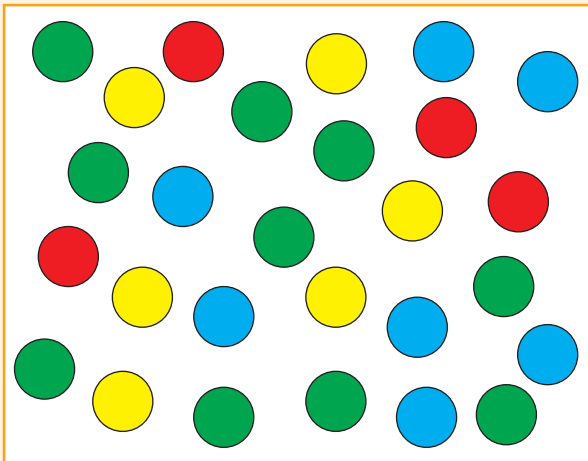
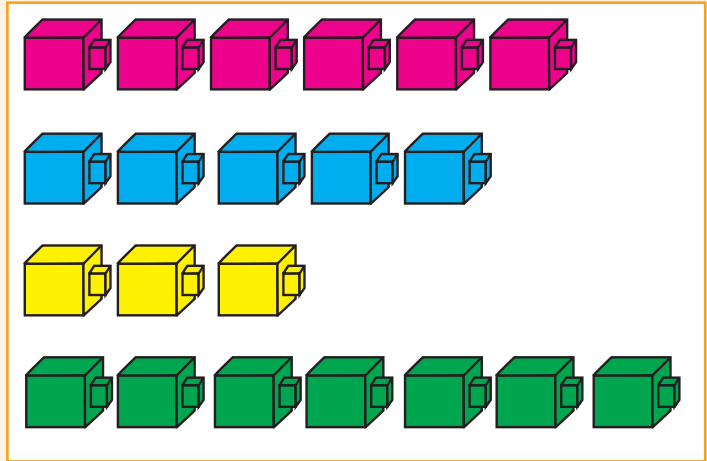
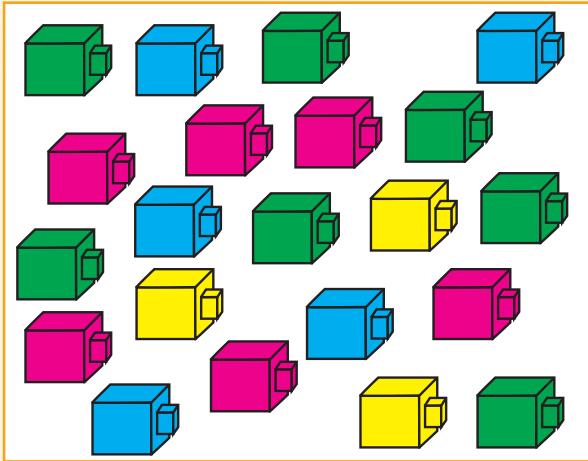



Sorteer die volgende blare deur 'n tekening te maak.



Hoeveel **geel** blare is daar?

Hoeveel **oranje** blare is daar?

Hoeveel **groen** blare is daar?



Onderwyser-
handtekening:

Datum:



Optelling tot by 10: tel aan

Teken 'n prent en skryf 'n getaltesin vir elkeen.

Sunet het 3 lekkers. Sipho het 2 lekkers. Hoeveel lekkers het hulle altesaam?



Ons tel:

3	4	5
---	---	---

<input type="text"/>	+	<input type="text"/>	=	<input type="text"/>
----------------------	---	----------------------	---	----------------------

Ek het 4 albasters en wen nog 3 albasters. Hoeveel albasters het ek nou?

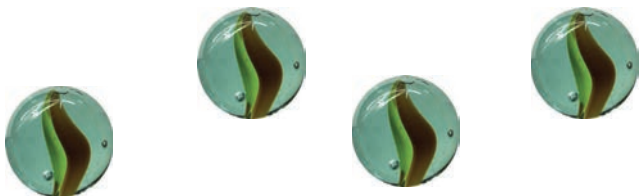

Ons tel:

4	5	6	7
---	---	---	---

<input type="text"/>	+	<input type="text"/>	=	<input type="text"/>
----------------------	---	----------------------	---	----------------------

Daar was 5 vlinders. Toe kom nog twee by. Hoeveel vlinders is daar nou?



Ons tel:

5	6	7	<input type="text"/>	<input type="text"/>
---	---	---	----------------------	----------------------

<input type="text"/>	-	<input type="text"/>	=	<input type="text"/>
----------------------	---	----------------------	---	----------------------



Vul die getalle op die getallelyn in en skryf dan 'n getallesin vir elkeen.

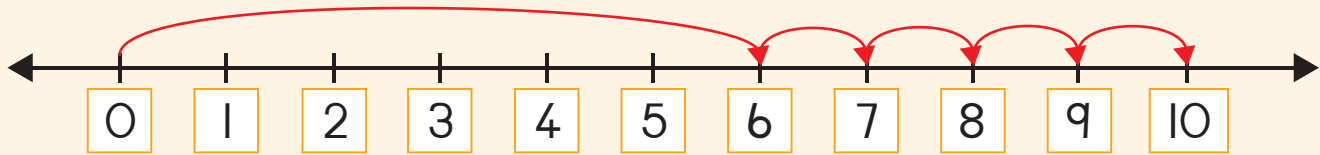

$$6 + 4 = \square$$

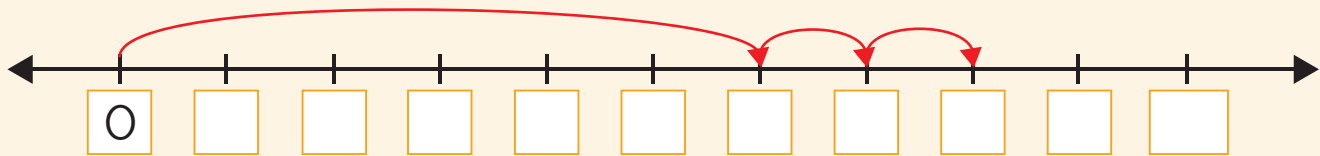

$$\square + \square = \square$$

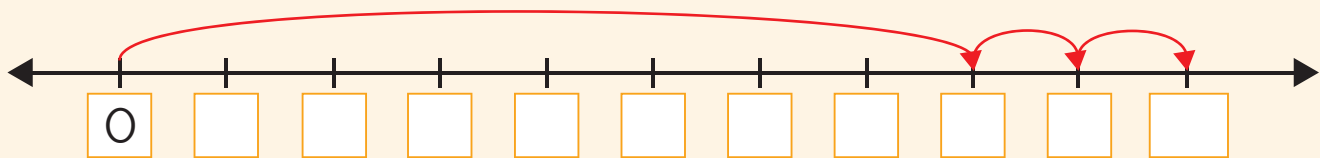

$$\square + \square = \square$$

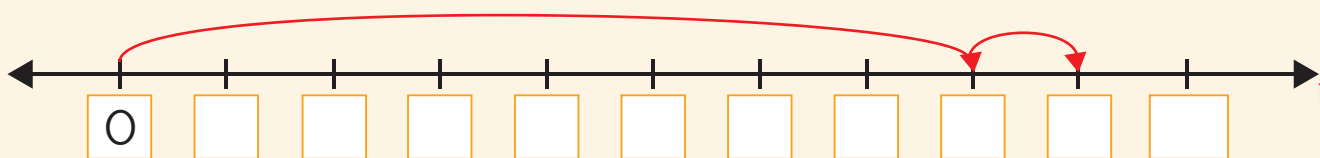

$$\square + \square = \square$$







Onderwyser-
handtekening:

Datum:

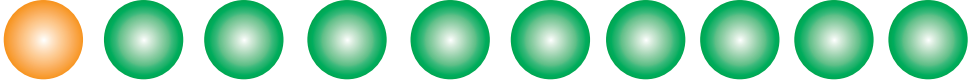

Optelling: bou en breek af tot by 10

Kleur in om die volgende te wys.

$1 + 9$	
$2 + 8$	
$3 + 7$	
$4 + 6$	
$5 + 5$	



Skryf 'n som vir:

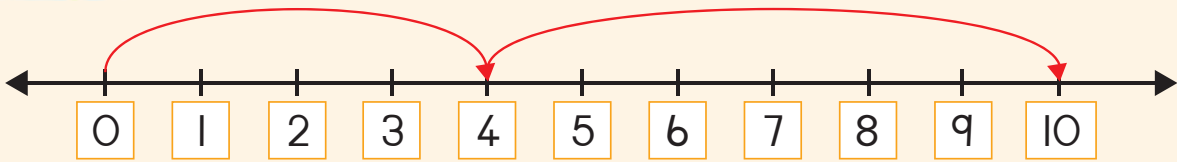

$$4 + 6 = \square$$

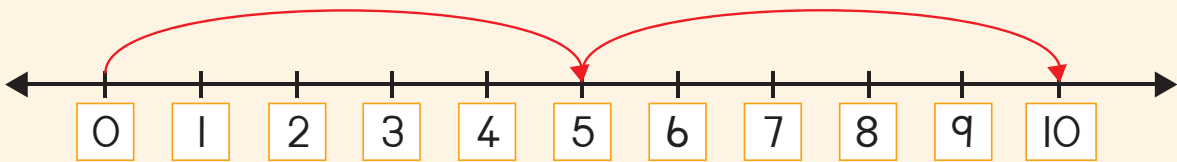

$$\square + \square = \square$$

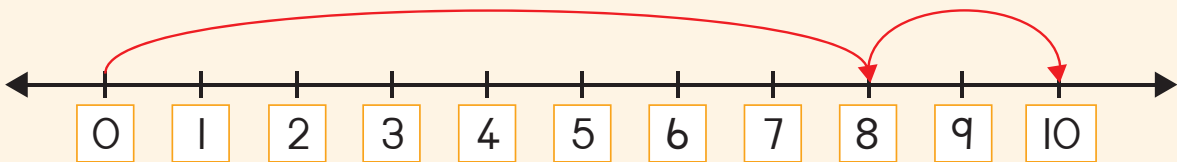

$$\square + \square = \square$$





Gebruik die aantal blomme om jou eie getallesinne te maak.



$$\square + \square + \square = \square$$



$$\square + \square + \square = \square$$



$$\square + \square + \square = \square$$



$$\square + \square + \square = \square$$



Skryf 'n som vir:

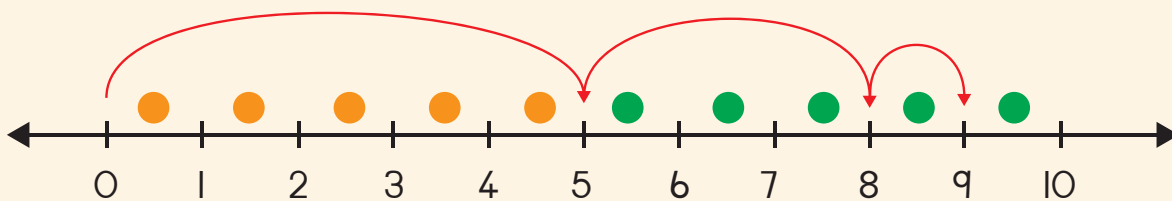

$$\square + \square + \square = \square$$

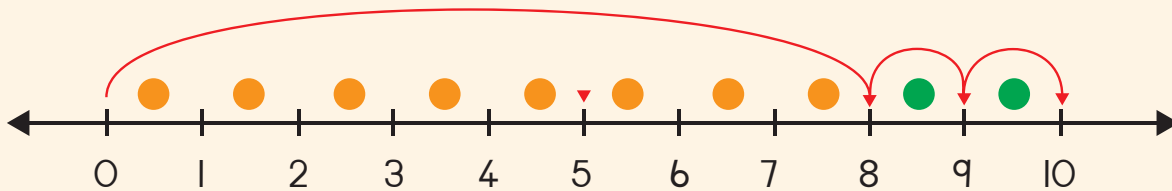

$$\square + \square + \square = \square$$



Onderwyser-handtekening:

Datum:





Verdubbeling en halvering

Beantwoord die volgende.

Hoeveel meisies sien jy?



Hoeveel meisies sien jy nou?



Dubbel 1 is 2.

Wat gebeur as ons die getal meisies halveer?

Hoeveel voete sien jy?



Hoeveel voete sien jy nou?



Ons sê dubbel 2 is 4.

Wat sal die helfte van 4 wees?

Hoeveel wiele sien jy?



Hoeveel wiele sien jy nou?



Ons sê dubbel 3 is 6.

Wat sal die helfte van 6 wees?

Hoeveel bene sien jy?



Hoeveel bene sien jy nou?



Ons sê dubbel 4 is 8.

Wat sal die helfte van 8 wees?

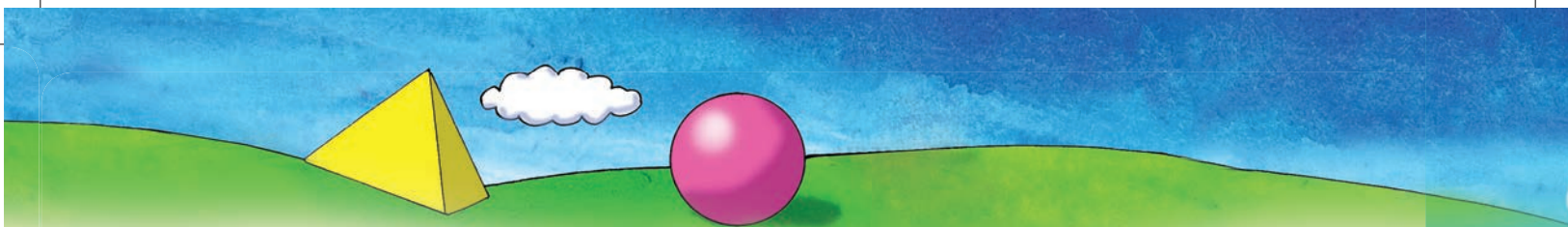

Hoeveel vingers sien jy?



Hoeveel vingers sien jy nou?



Ons sê dubbel 5 is 10.
Wat sal die helfte van 10 wees?



Los die volgende op deur dit in te kleur. Skryf die som neer.

Ek het 4 albasters en my maat het ook 4. Hoeveel albasters het ons altesaam?
Kleur die regte getal albasters in.

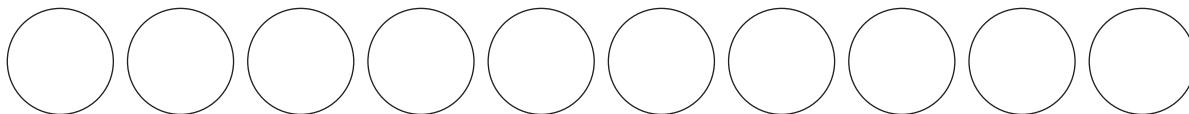

$$\square + \square = \square$$



Beantwoord die volgende.

Dubbel 1 is

Dubbel 2 is

Dubbel 3 is

Dubbel 4 is

Dubbel 5 is

Die helfte van 2 is

Die helfte van 4 is

Die helfte van 6 is

Die helfte van 8 is

Die helfte van 10 is

Onderwyser-
handtekening:

Datum:



Voltooi hierdie vorms.

vierkant

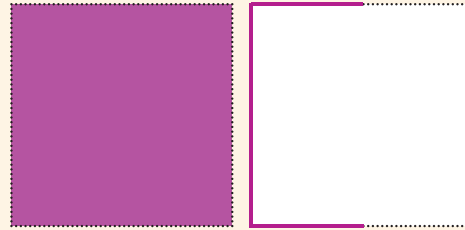

sirkel

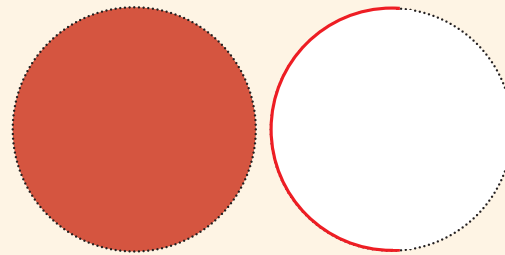

driehoek

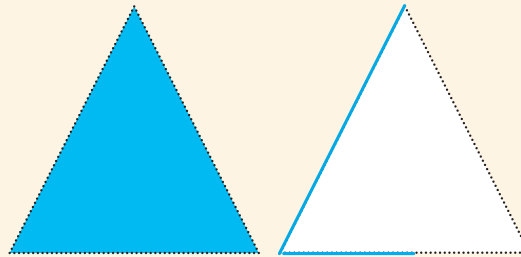

reghoek



Gebruik die vier vorms hierbo om 'n prentjie te teken. Jy kan die vorms meer as een keer gebruik.

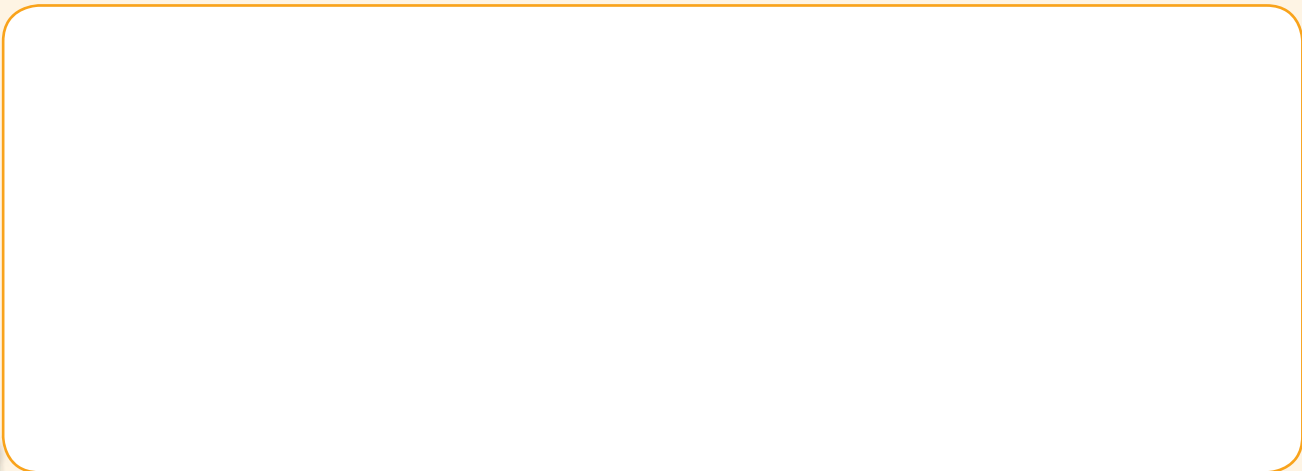

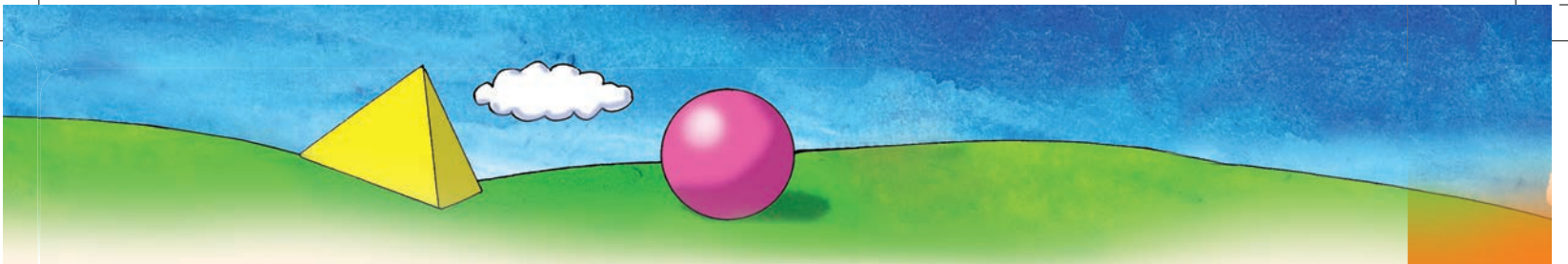

Gebruik jou uitknipsel vorms om hierdie figure te maak.

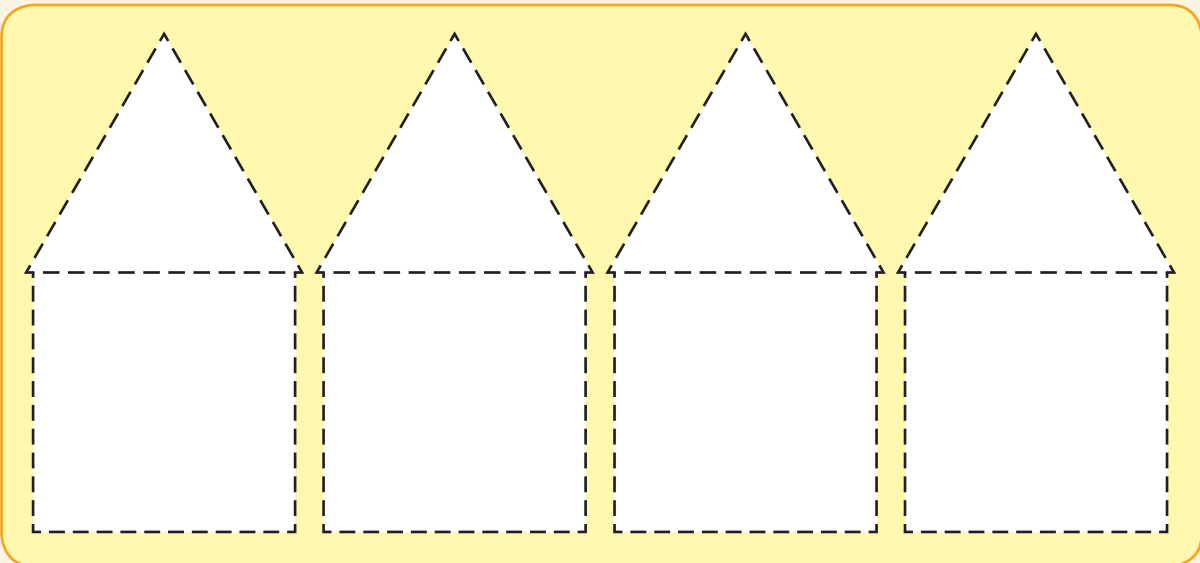
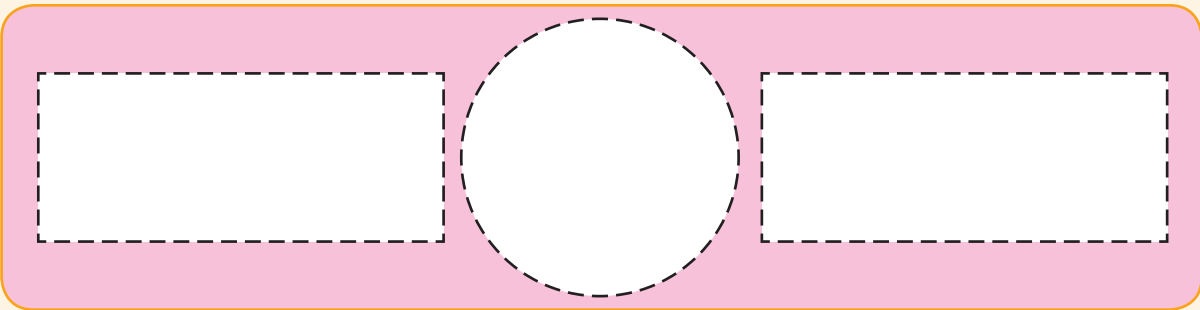
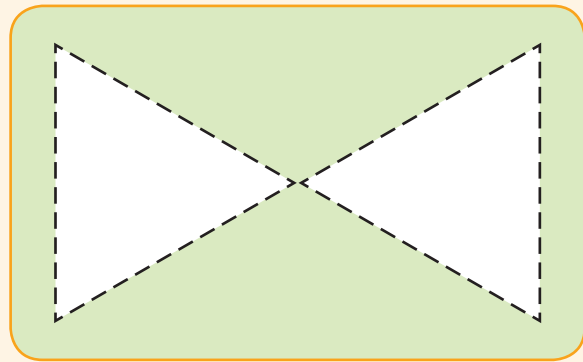
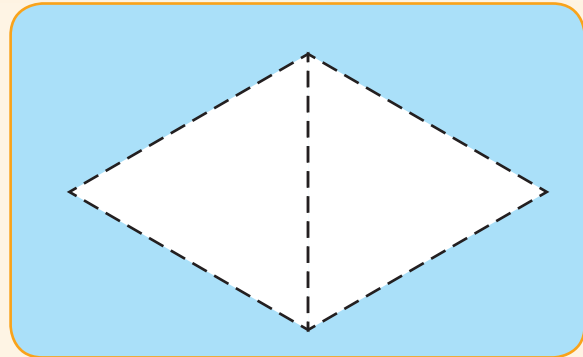
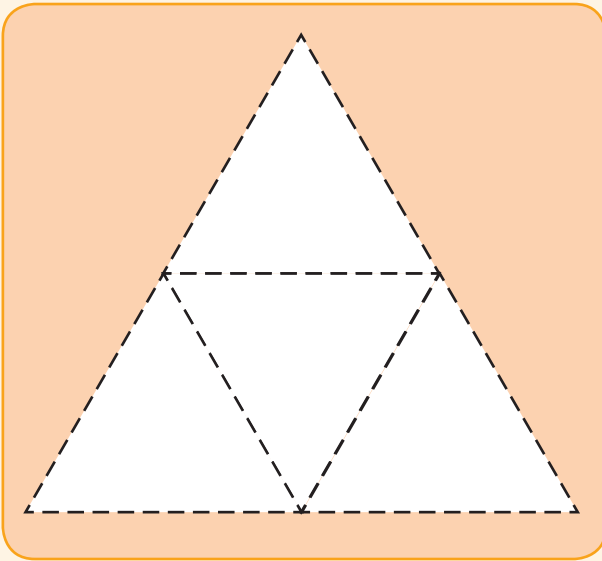

Onderwyser-handtekening:

Datum:



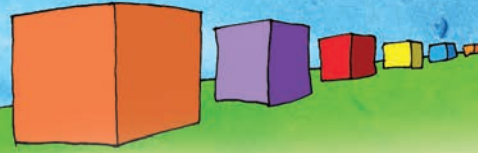

Nog 2-D vorms



Sorteer die vorms en maak 'n tekening van jou sorteerwerk.

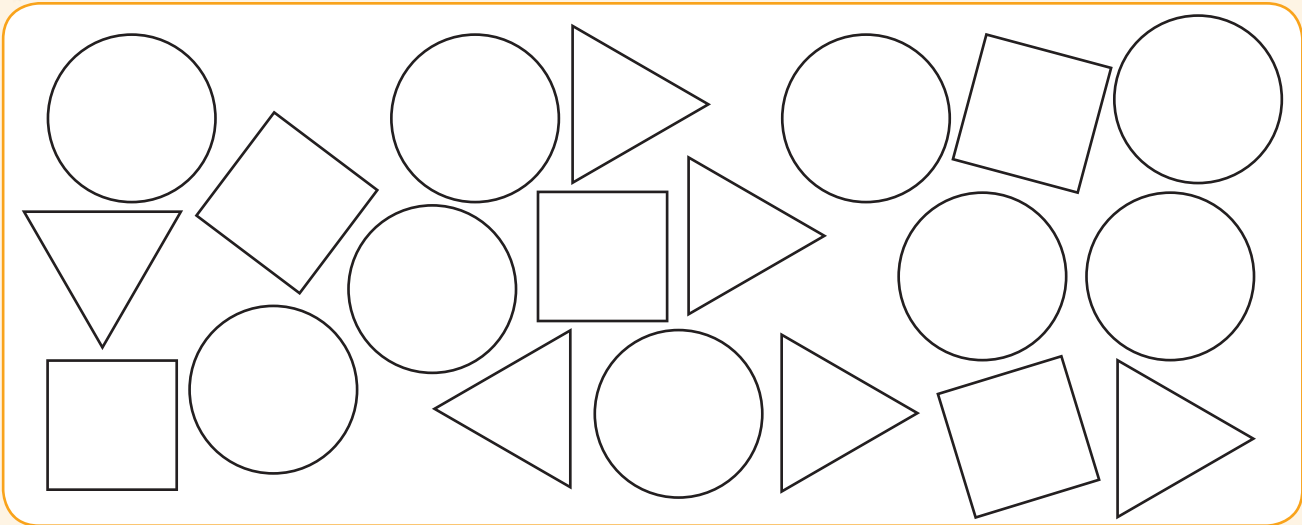

Driehoeke

Sirkels

Vierkante

Hoeveel driehoeke is daar?

Hoeveel sirkels is daar?

Hoeveel vierkante is daar?



Soek die vorms



Soek die verskillende vorms en tel hulle.

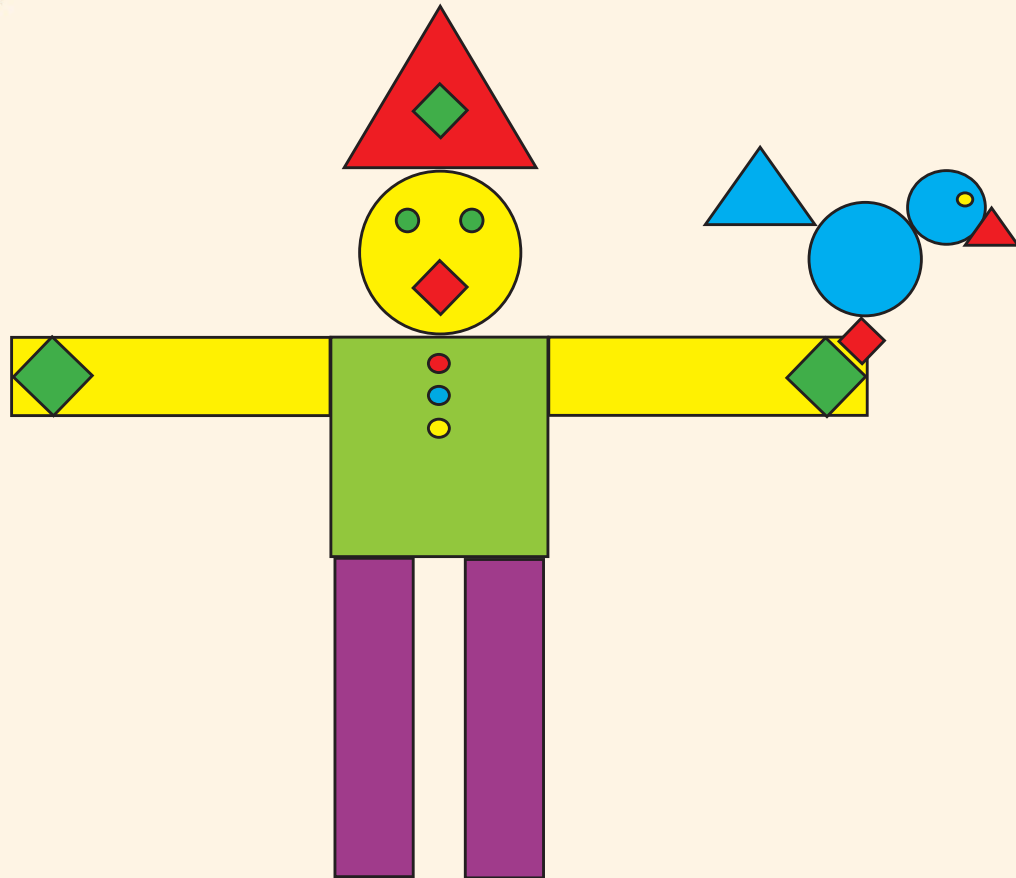

	Hoeveel vierkante is daar?	
	Hoeveel sirkels is daar?	
	Hoeveel driehoeke is daar?	
	Hoeveel reghoeke is daar?	



Onderwyser-
handtekening:

Datum:



Groepe van twee tot 10

Beantwoord die vrae:

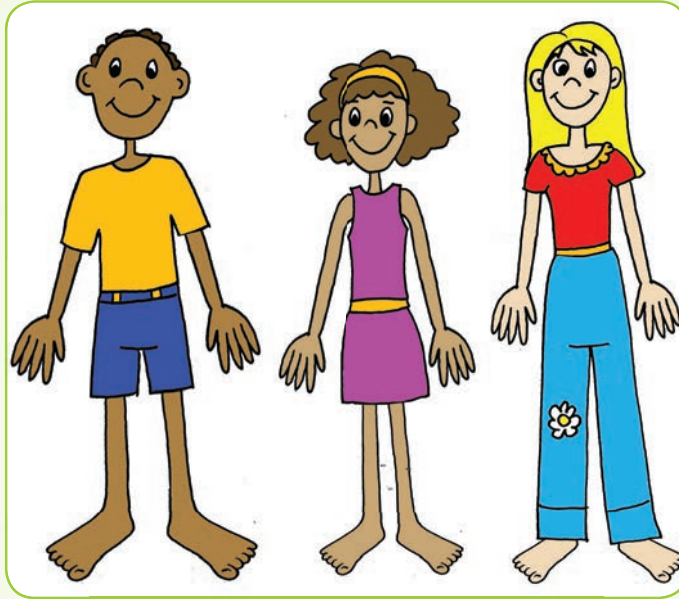

Hoeveel kinders sien jy?

Hoeveel pare voete sien jy?

Skryf 'n som vir die pare voete.

$$2 + 2 + 2 =$$



Trek sirkels om die volgende te maak.

2 groepe van 2



4 groepe van 2

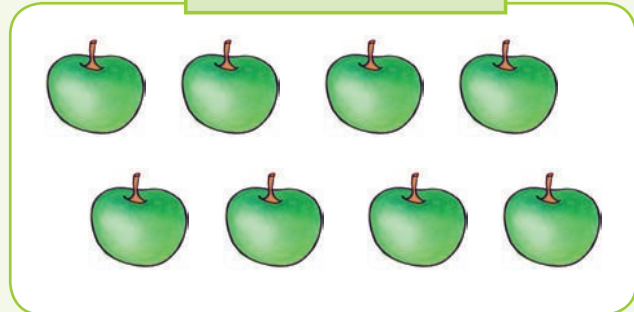



5 groepe van 2



3 groepe van 2



Skryf 'n som vir die volgende:

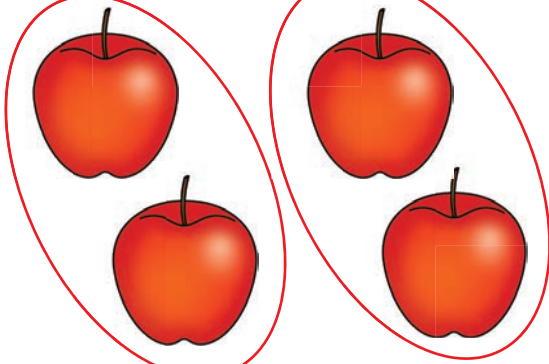

$2 + 2 =$

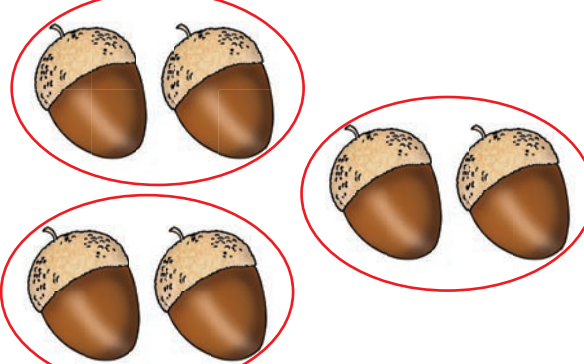
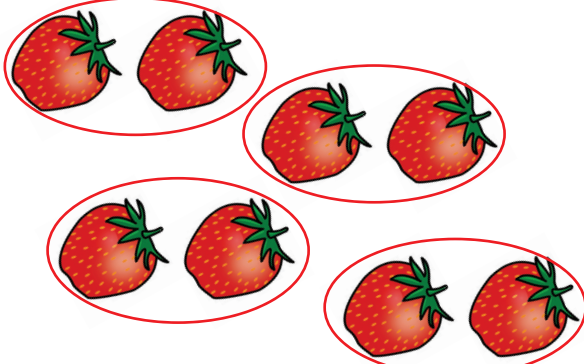
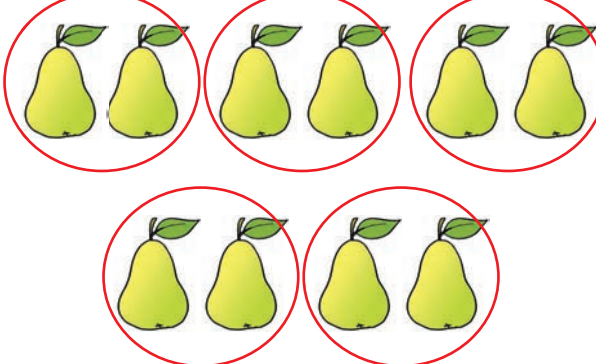

Onderwyser-
handtekening:

Datum:



Herhaalde optelling van twees tot by 10

Hoeveel bene is daar? Skryf 'n som daarvoor.



$$2 + 2 + 2 = 6$$



$$\square + \square + \square + \square + \square = \square$$



$$\square + \square = \square$$



$$\square + \square + \square + \square = \square$$



Bereken en maak dan 'n tekening.

2	+	2	=	4

2	+	2	+	2	=	□

2	+	2	+	2	+	2	=	□

2	+	2	+	2	+	2	+	2	=	□





Skryf 'n som vir:

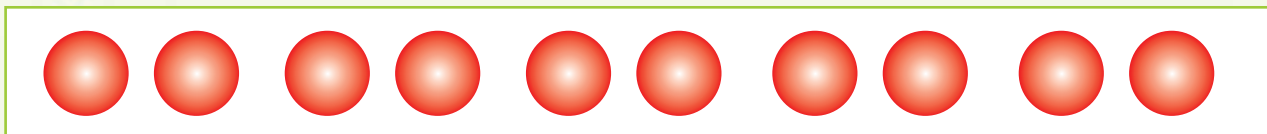

$2 + 2 + 2 + 2 + 2 =$

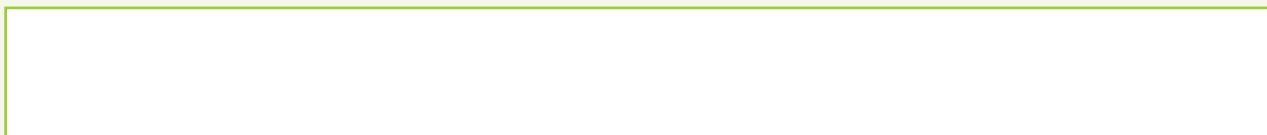
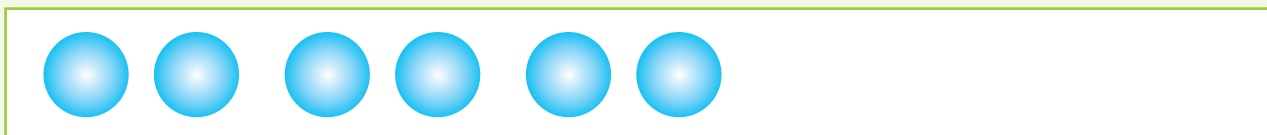
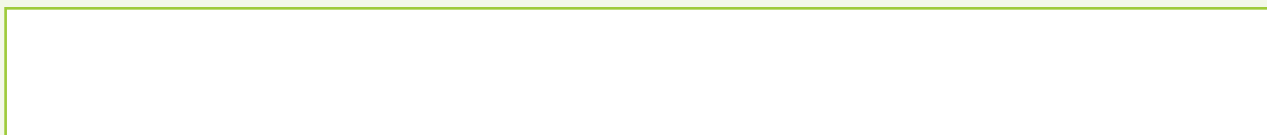
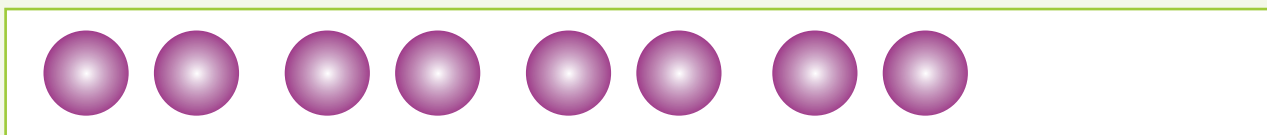
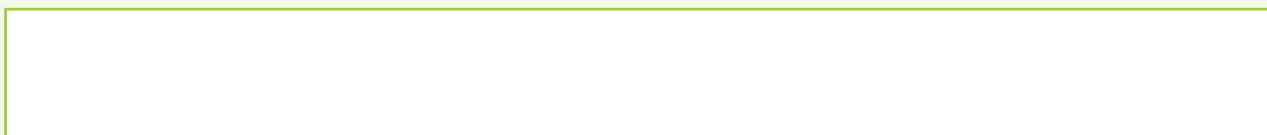
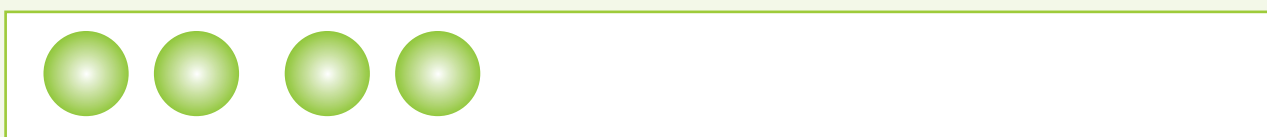

Tel hierdie getalle in twees en kleur dan al die twees in.

1	2	3	4	5	6	7	8	9	10
---	---	---	---	---	---	---	---	---	----



Onderwyser-handtekening:

Datum:





Patrone: 2 tot 20

Trek 'n streep na die ontbrekende getal toe.
Ons het die eerste een vir jou gedoen. Voltooi dan nog twee spronge.

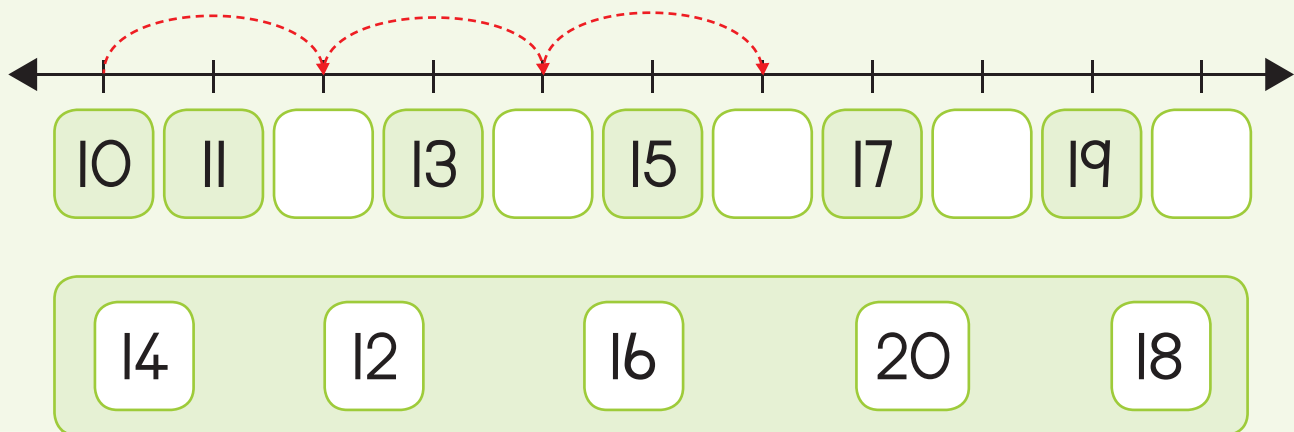
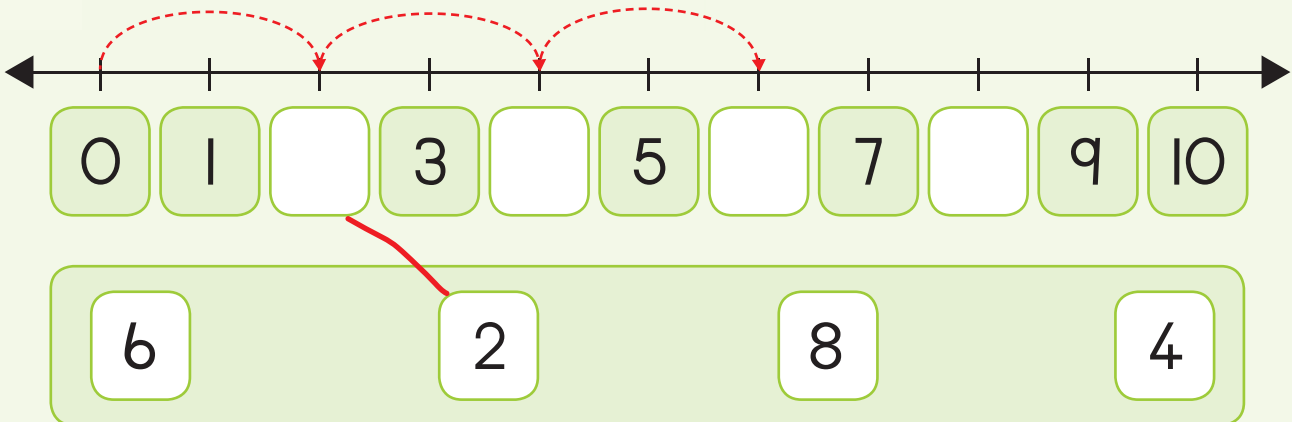

Voltooi die patroon deur die getalle in te kleur.

1	2	3	4	5	6	7	8	9	10
11	12	13	14	15	16	17	18	19	20



Teken spronge om die volgende te wys.

8 10 12 14

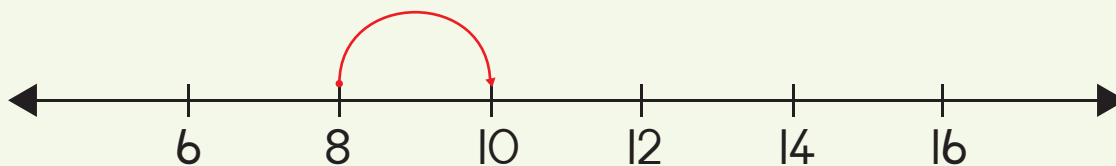

12 14 16 18

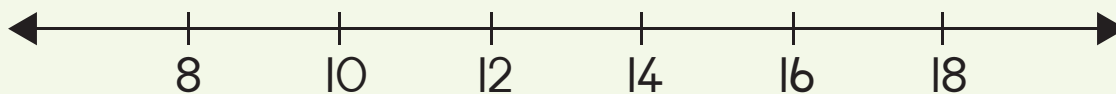

4 6 8 10



Onderwyser-
handtekening:

Datum:





Groepe van drie tot by 10

Beantwoord die vrae.

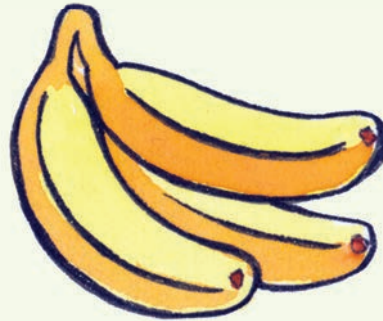
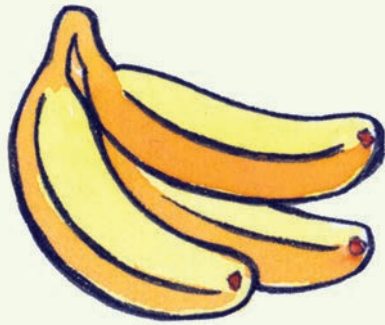

Hoeveel piesangs tel jy?

Hoeveel groepe is daar?

Skryf dit as 'n getallessin.



Trek sirkels om die volgende te maak:

2 groepe van 3

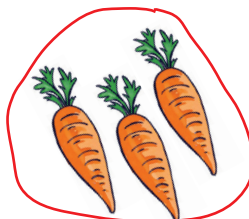

3 groepe van 3





4 groepe van 3



1 groep van 3

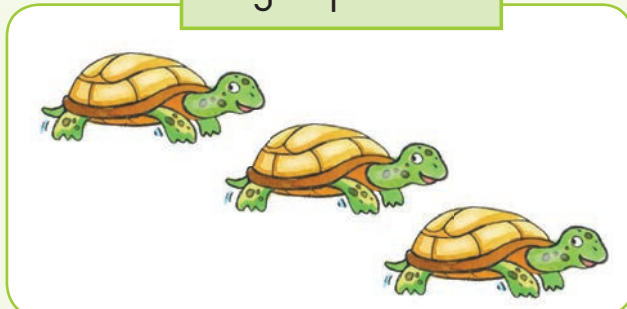

Skryf 'n getaltesin vir die volgende:

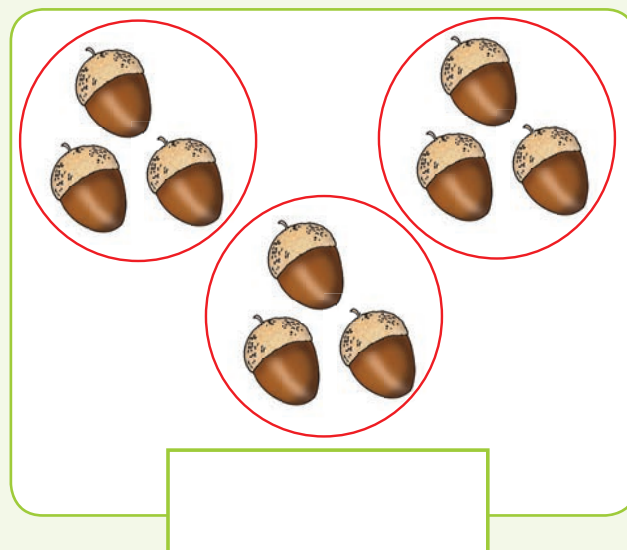
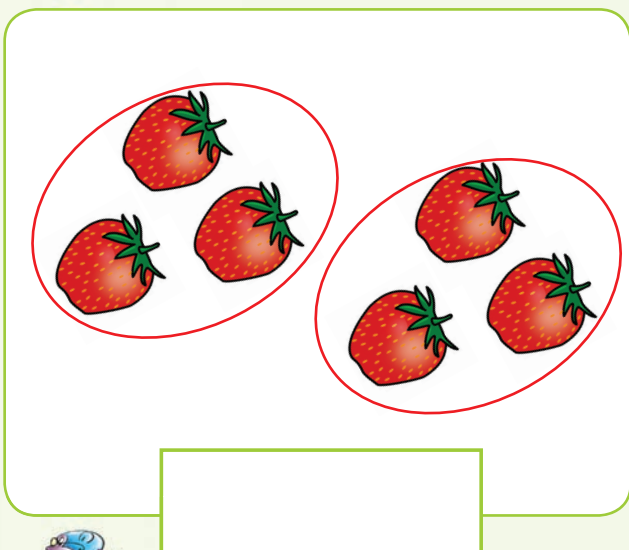

Teken 2 groepe van 3.

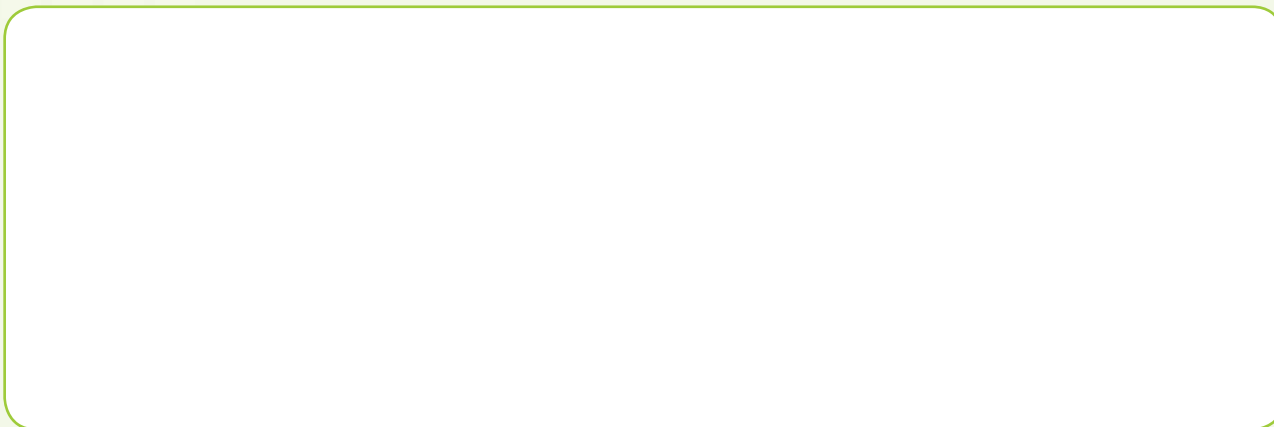

Onderwyser-handtekening:

Datum:





Herhaalde optelling van drieë tot by 10

Hoeveel wiele is daar? Skryf dit as 'n som.











Teken vorms om die volgende te wys.

$$3 + 3 = \square$$

$$3 + 3 + 3 = \square$$



Skryf 'n som vir:

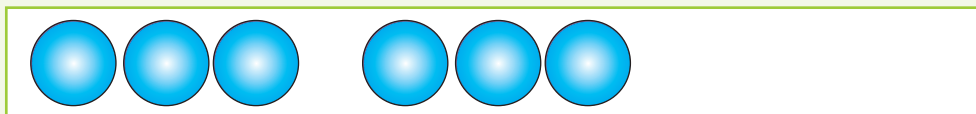
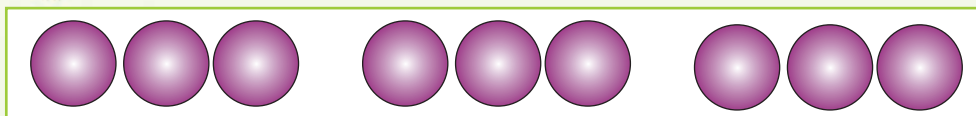

Hoeveel blomme het jy by die mark gekoop?



Som.



Onderwyser-handtekening:

Datum:





Groepe van vier tot by 10

Tel die vorms en skryf die getal neer.

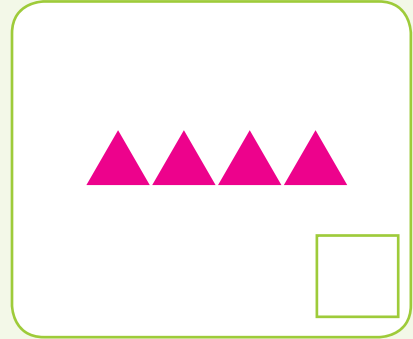
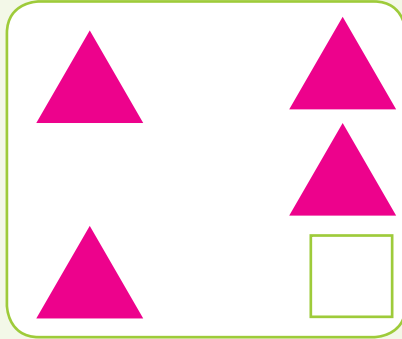
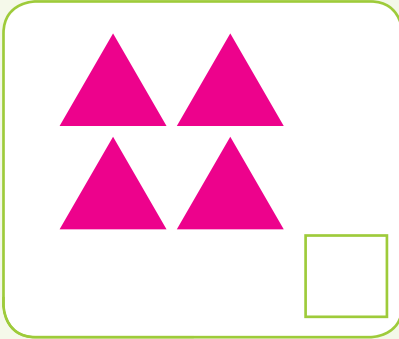

Ek het die volgende diere in die dieretuin gesien. Hoeveel bene het ek gesien?
Skryf 'n som vir elkeen.



$$4 + 4 = 8$$









Trek sirkels om die volgende te maak.

2 groepe van 4



1 groep van 4



2 groepe van 4

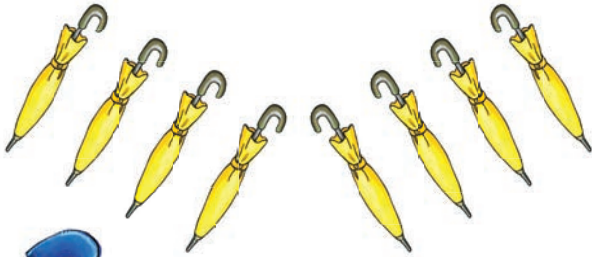

1 groep van 4



Skryf 'n som vir die volgende:

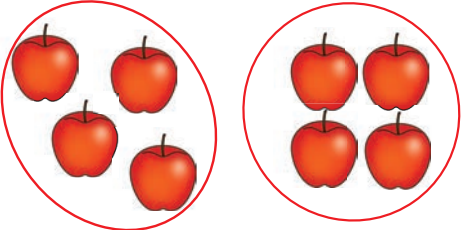

$4 + 4 =$

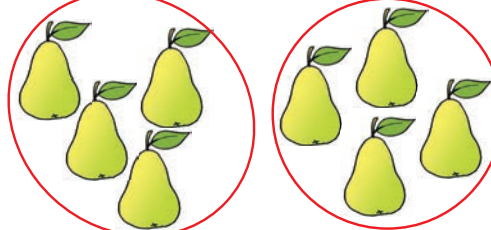

Onderwyser-handtekening:

Datum:





Herhaalde optelling van viere tot by 10

Hoeveel bene is daar? Skryf 'n som vir elkeen.



$$\square + \square = \square$$

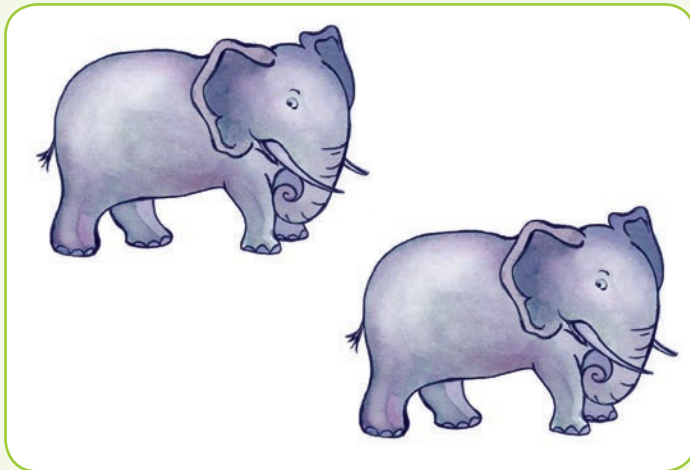

$$\square + \square = \square$$

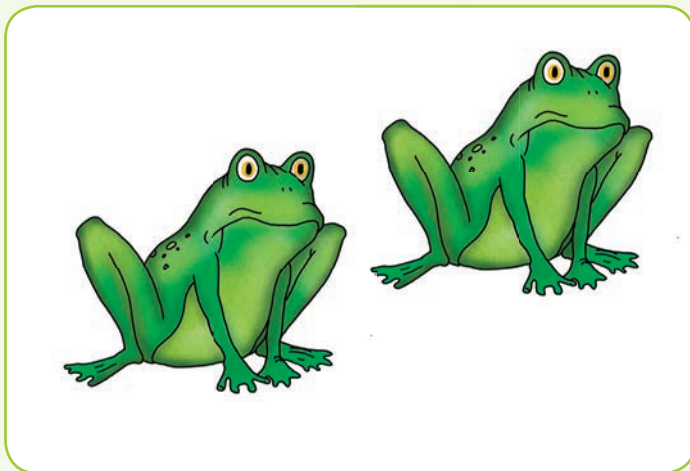

$$\square + \square = \square$$





Teken vorms om die volgende te toon.

$$4 + 4 = \square$$



Skryf 'n som vir:

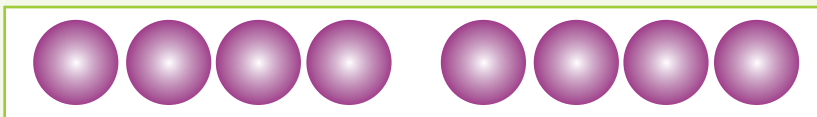

Susan bak 4 kolwyntjies. Jana bak 4 kolwyntjies.
Hoeveel kolwyntjies het hulle altesaam gebak? Omkring die korrekte getal kolwyntjies.



Som.



Onderwyser-
handtekening:

Datum:



Beantwoord die vrae.

Groepe van vyf tot by 10

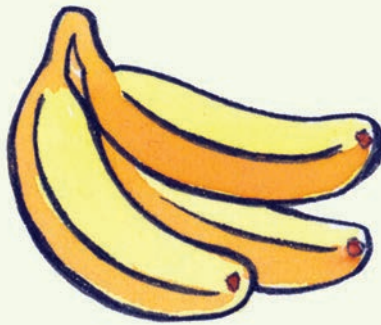

Hoeveel tone sien jy aan elke voet?

Hoeveel tone is daar altesaam?

Skryf dit as 'n som.

$$5 + 5 =$$



Trek sirkels om die volgende te maak.

1 groep van 5



2 groepe van 5





2 groepe van 5



1 groep van 5



Skryf 'n som vir die volgende:

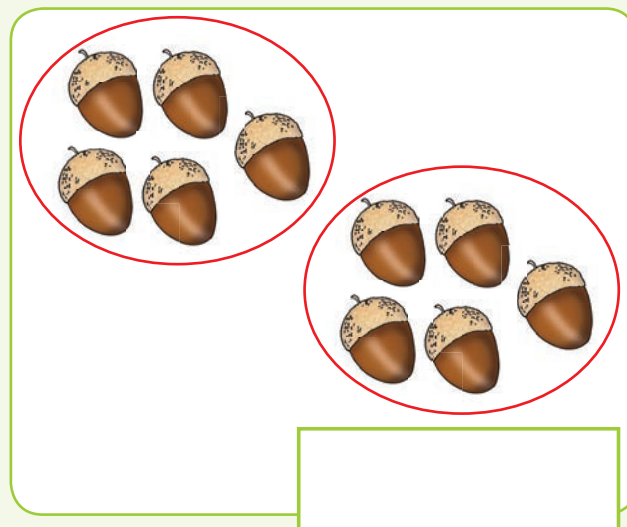
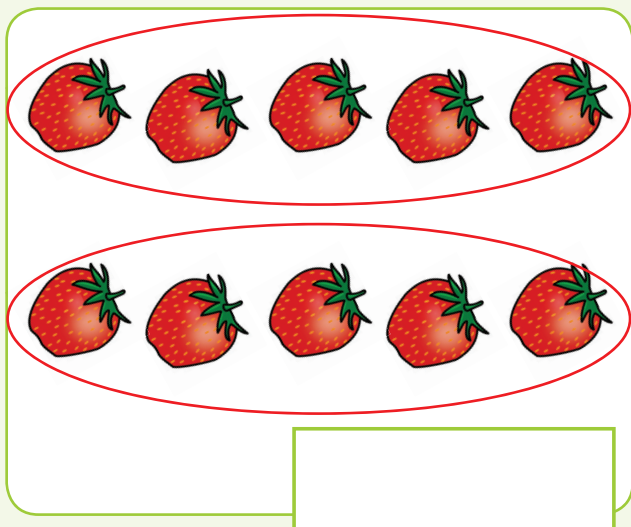
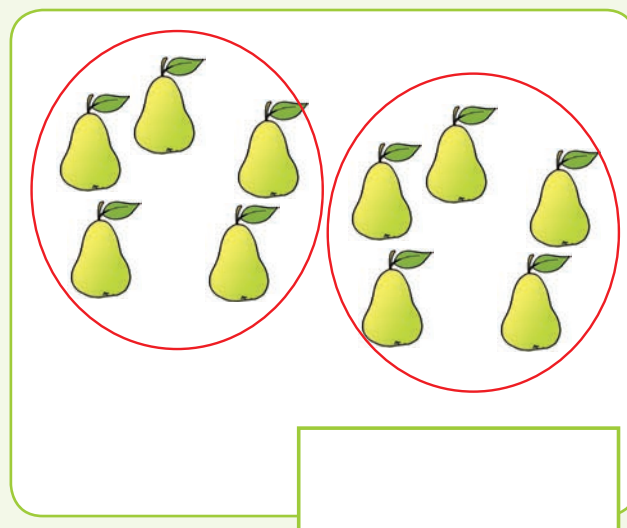
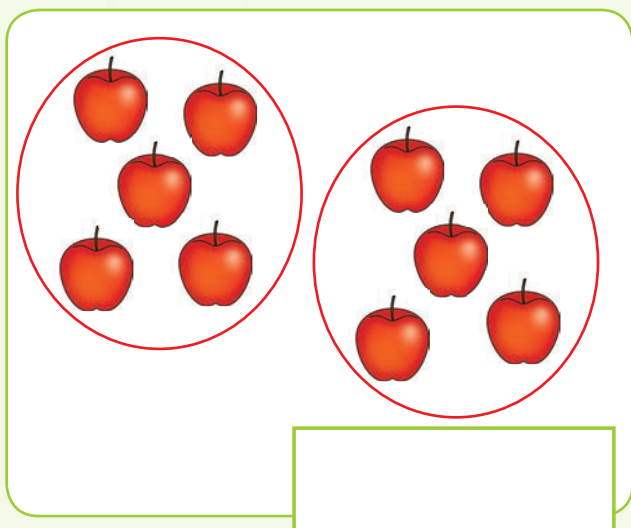

Onderwyser-handtekening:

Datum:





Herhaalde optelling van vywe tot by 10

Hoeveel vingers of tone is daar?

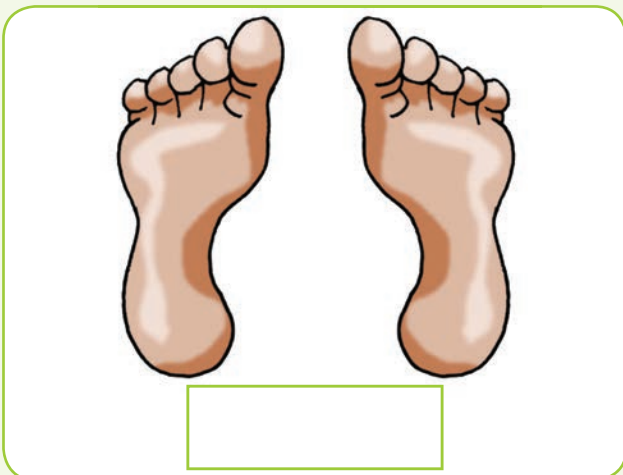
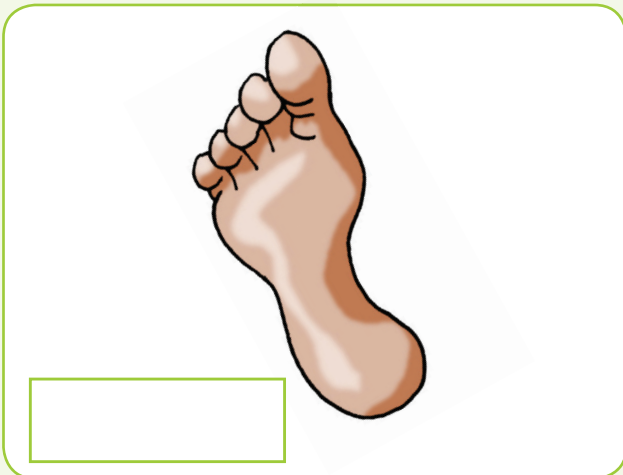
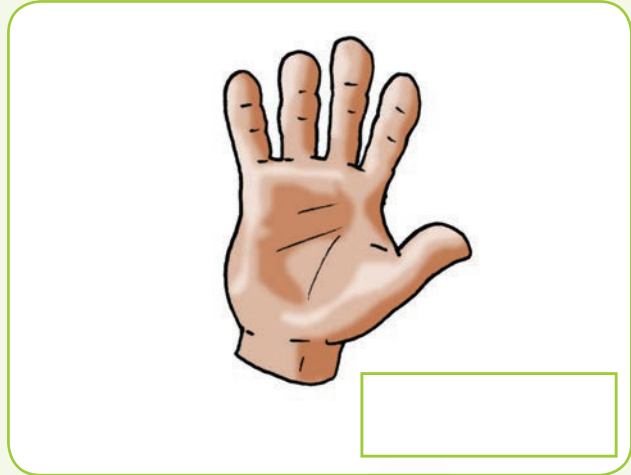
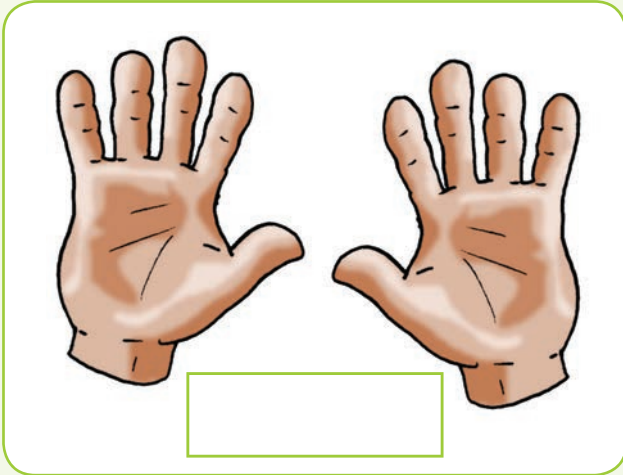



Teken vorms om die volgende te wys.

$$5 + 5 = \square$$



Skryf 'n som vir:

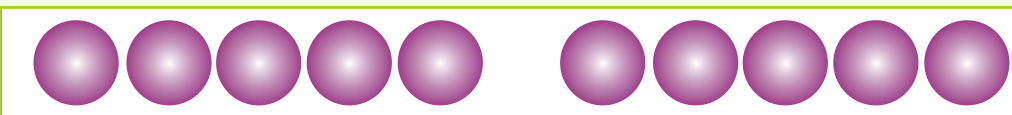

Hoeveel tone het jy aan elke voet? Hoeveel tone het jy altesaam?
Maak 'n tekening.

Som:



Hoeveel vingers het jy aan een hand? Hoeveel vingers het jy altesaam?
Maak 'n tekening.

Som:



Onderwyser-
handtekening:

Datum:





Patrone: 5 tot 20

Trek 'n streep om te wys watter getal ontbreek. Ons het die eerste een vir jou gedoen.
Voltooi die spronge deur hulle na te trek.

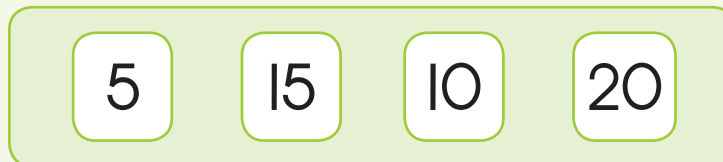
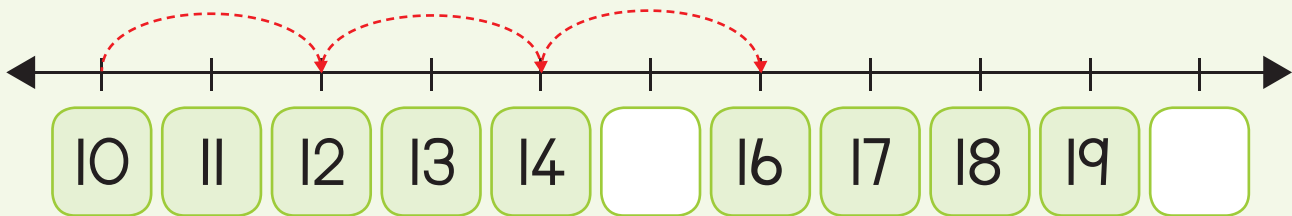
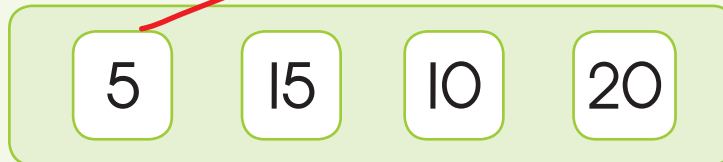
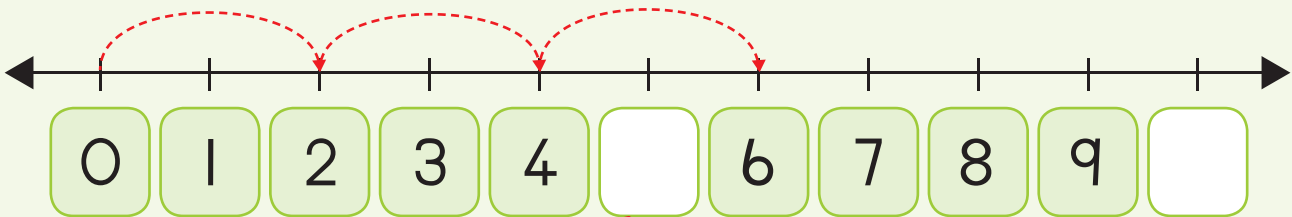

Voltooi die patroon deur die getalle in te kleur.

1	2	3	4	5	6	7	8	9	10
11	12	13	14	15	16	17	18	19	20



Teken spronge om die volgende te wys:

0

5

15

20

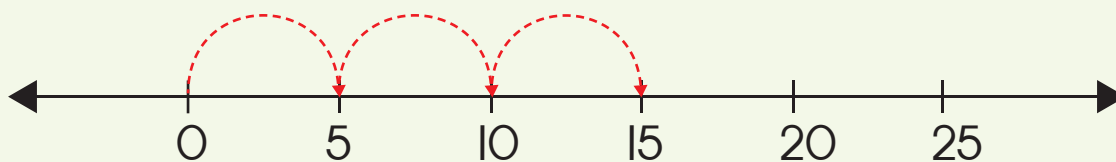

20

25

30

35

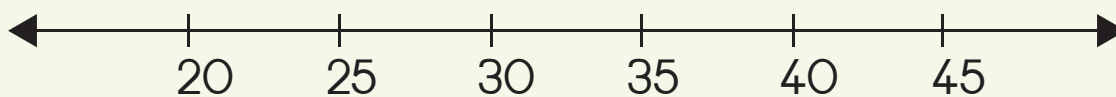

35

40

45

50

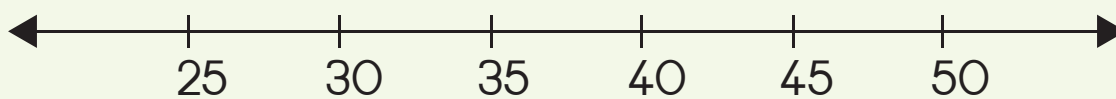

Onderwyser-
handtekening:

Datum:

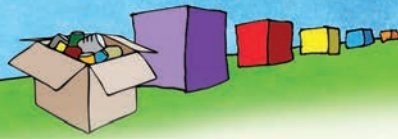

Patrone: Tiene



Vul die ontbrekende getalle in.

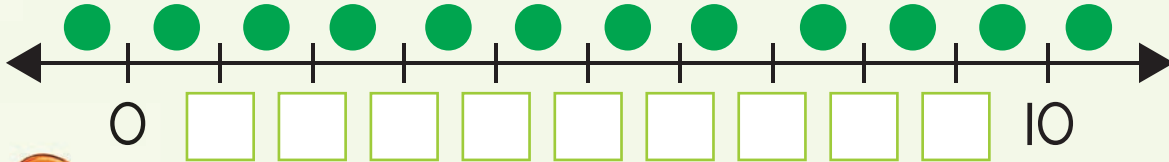

Teken 10 krale tussen die intervale en wys die getal wat by elke blokkie pas.

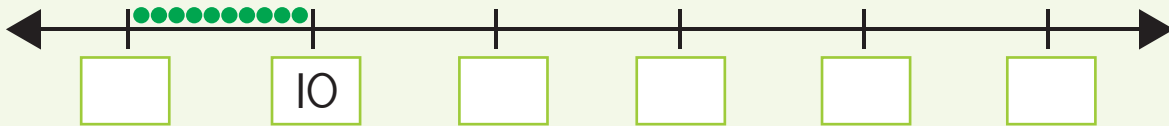

50 40 30 20



Voltooi die getallelyn deur die getalle wat gegee is in die regte spasies oor te skryf.

50 30 10 0 50 20 40





Voltooi die getallebord met die knipselgetalle.

1	2	3	4	5	6	7	8	9	
11	12	13	14	15	16	17	18	19	
21	22	23	24	25	26	27	28	29	
31	32	33	34	35	36	37	38	39	
41	42	43	44	45	46	47	48	49	
51	52	53	54	55	56	57	58	59	
61	62	63	64	65	66	67	68	69	
71	72	73	74	75	76	77	78	79	
81	82	83	84	85	86	87	88	89	
91	92	93	94	95	96	97	98	99	

Gebruik hierdie knipselgetalle agter in die boek.



20	40	10	60	90	80
50	30	100	70		



Onderwyser-
handtekening:

Datum:



11 12 13 14 15 16 17 18 19 20

60a

Kwartaal 2



Geld

Verbind die getal met die regte noot.

R100		
R20		
R10		
5c		
R50		
50c		
R5		
R1		







Geld: note en munte

Omkring die geldnote/munte met die meeste waarde.

		
 R100	R50	R10

		
RI	R5	R10

		
RI	50c	5c

		
R20	R5	R10



Onderwyser-handtekening:

Datum:



60b

Kwartaal 2



Geld (vervolg)



Omkring al die:

5c-munte



10c-munte



20c-munte



Omkring al die:

R10-note



Omkring al die:

R20-note





Omkring die munte in elke ry wat 20c sal maak.



Omkring die note in elke ry wat R20 sal maak.



Onderwyser-handtekening:

Datum:





Geld en kleingeld

Teken die munte wat jou altesaam die volgende sal gee.

a.

10c

5c

b.

20c

c.

15c





Tel die munte. Kleur die regte antwoord in.

	10c	15c	20c
	10c	15c	20c
	10c	15c	20c



Ek het soveel in my spaarvarkie. Wat kan ek daarmee koop?
Teken of plak 'n prentjie in die blokkie.



Onderwyser-
handtekening:

Datum:





Nog geld en kleingeld



Trek een 5c-muntstuk af. Hoeveel het jy oor?



5c



Hoeveel bly oor?

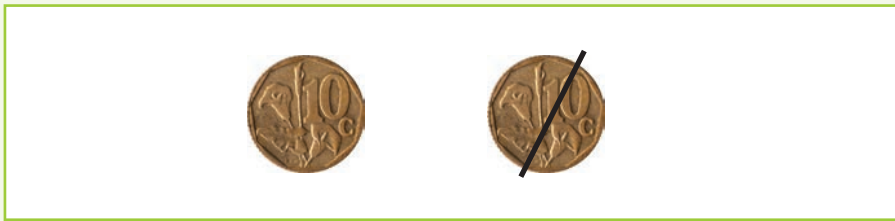
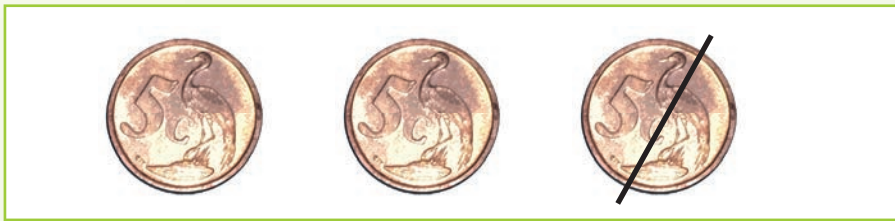



Hoeveel bly oor? Kies die getalle wat by die munte pas.



5c



20c

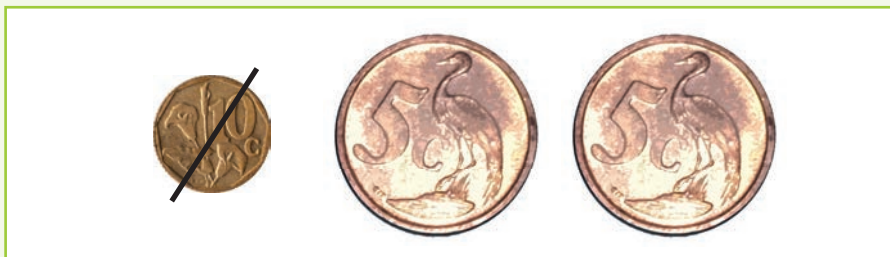

15c

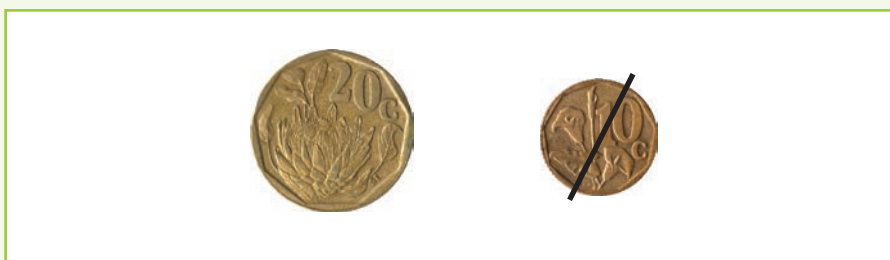

10c



Onderwyser-
handtekening:

Datum:

Vorm, oriëntasie en posisie

Omkring die vorm wat dieselfde fatsoen en oriëntasie as die vorm in die eerste raampie het.



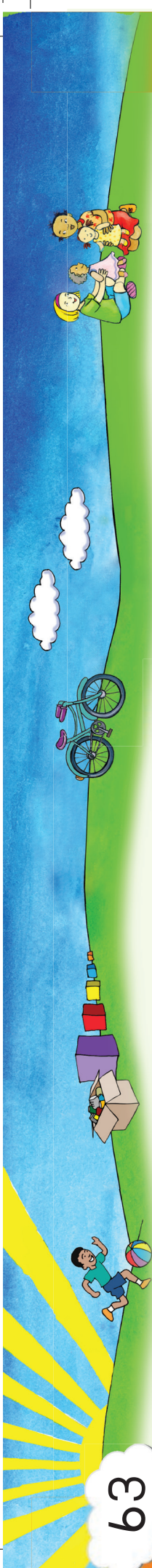

Omkring die regte antwoord.

1	2	3	4	5
Watter dier staan voor die olifant?	Watter dier staan agter die hond?	Watter dier staan tussen die sebra en die hond?	Teen watter dier sal die hond bots as hy vorentoe beweeg?	Teen watter dier sal die olifant bots as hy agtertoe beweeg?



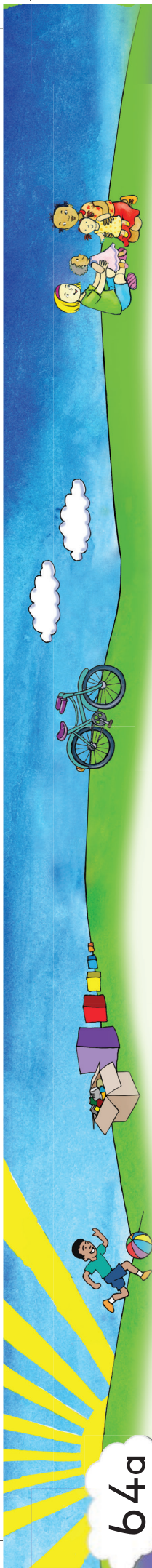

Patrone met meetkundige vorms



Brei die patroon uit met nog een vorm.

Skep jou eie patroon met die vorms wat gegee is.





Teacher: _____
 Day: _____
 Date: _____



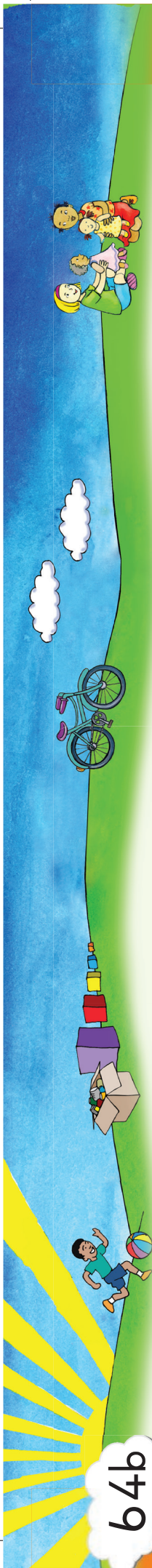



2D - vorms en 3D - voorwerpe



Kleur die vorms in.

Kleur die vierkante  rooi in.

Kleur die sirkels  blou in.

Kleur die driehoeke  groen in.

Kleur die kubusse  geel in.

Kleur die ballie  pers in.

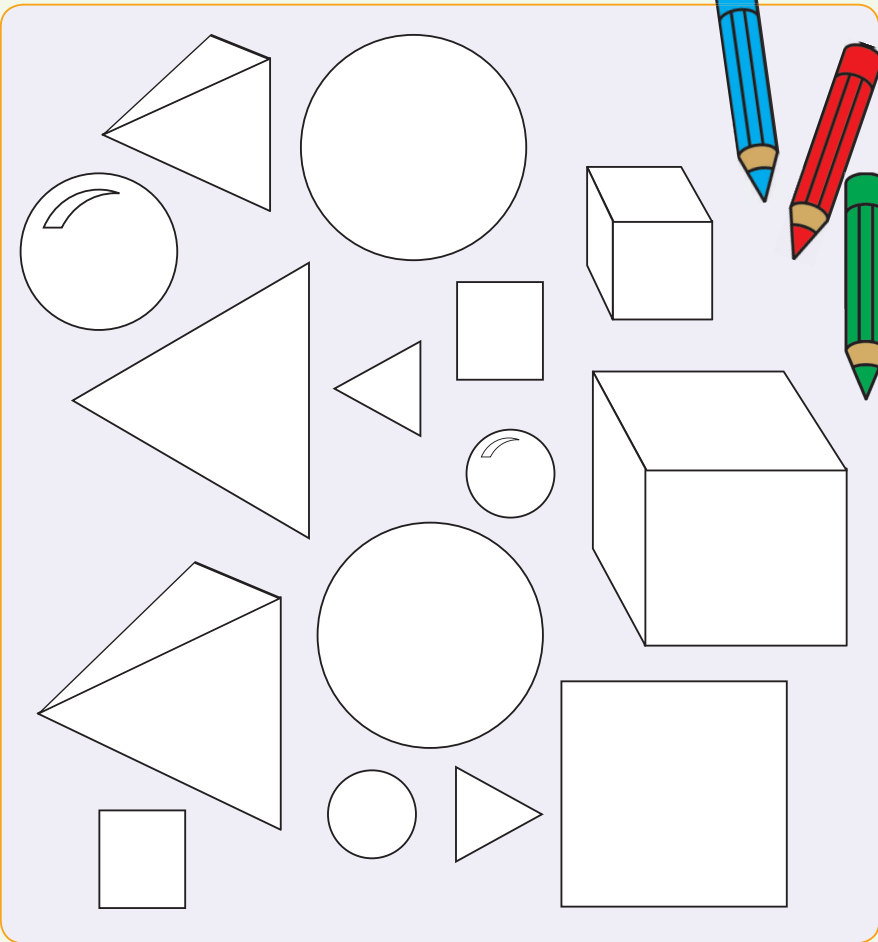

Kleur die prisma's  oranje in.







Vorms en soliede voorwerpe



Omkring die figure.

Omkring  in rooi. 

Omkring  in blou. 

Omkring  in groen. 

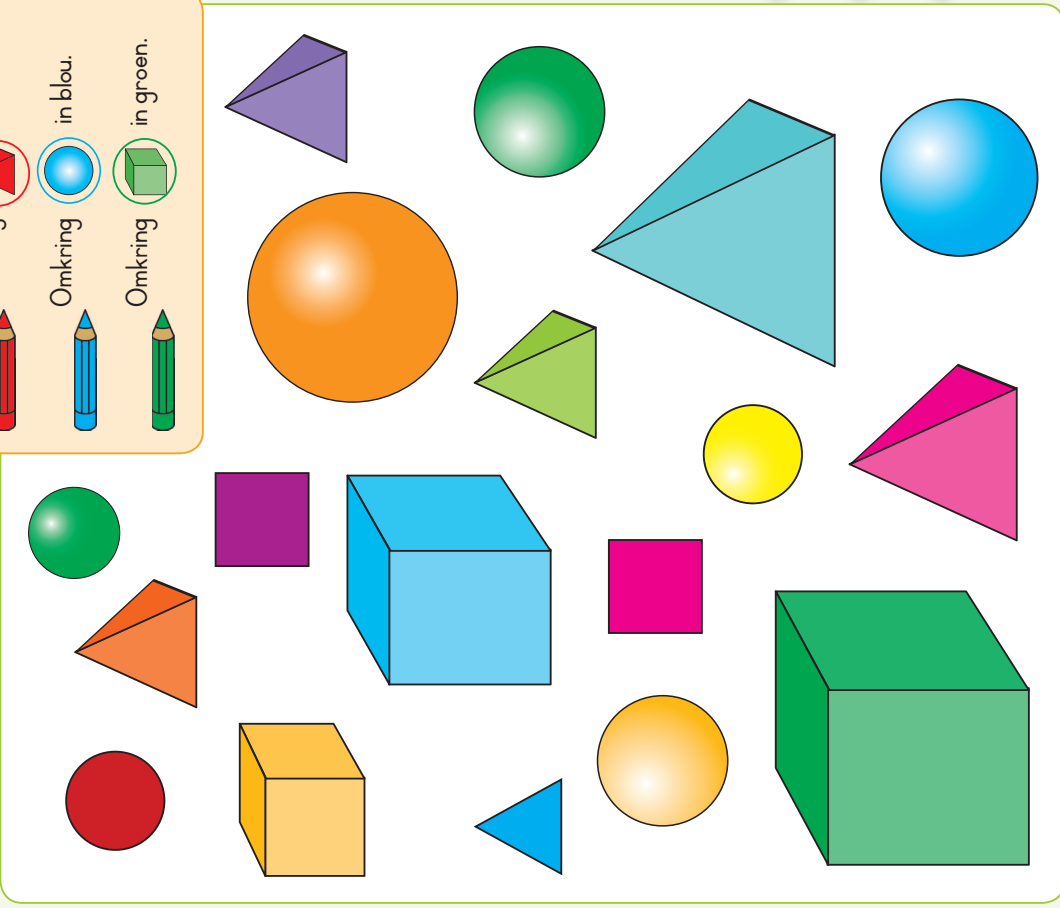

Teacher: _____
 Day: _____
 Date: _____



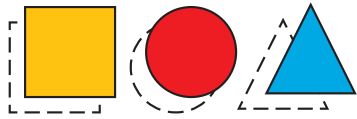

Shapes:

Cut out the shapes on the dotted lines. Now use them to do the worksheets in your book. Remember to keep them safe so that you can use them over and over again.

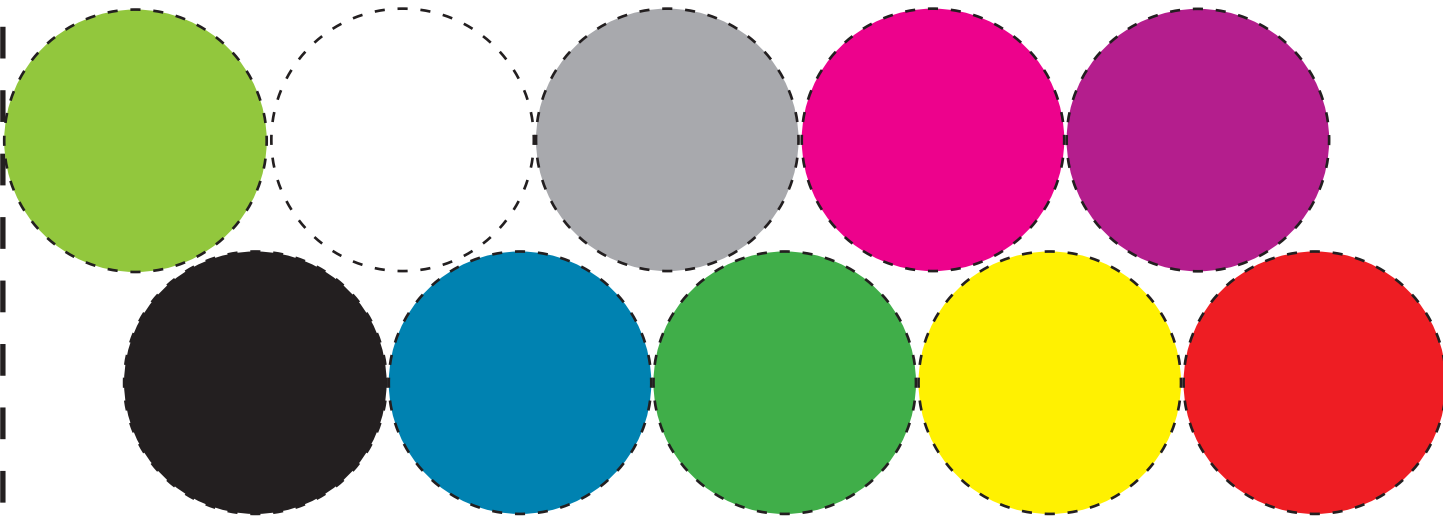
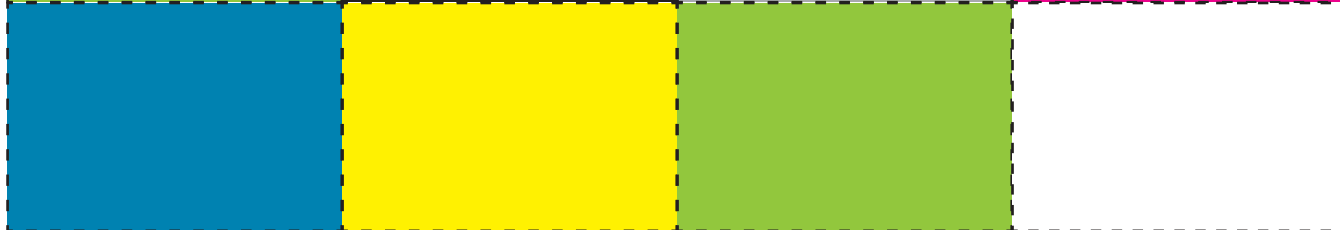
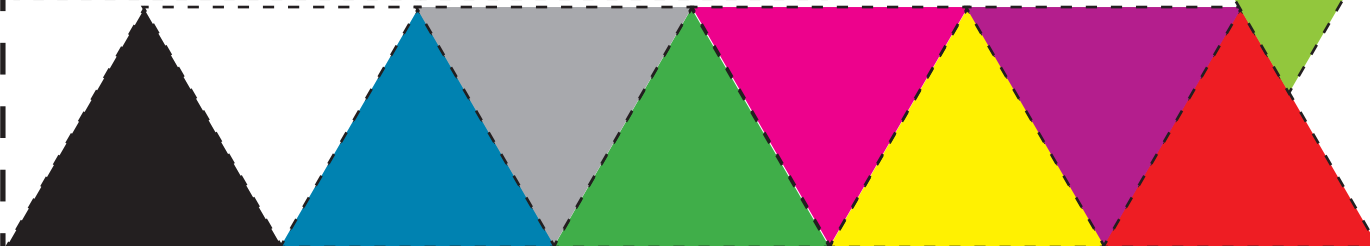
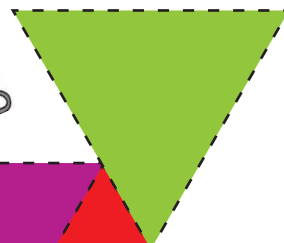
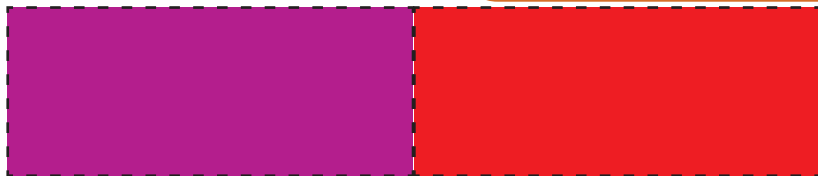

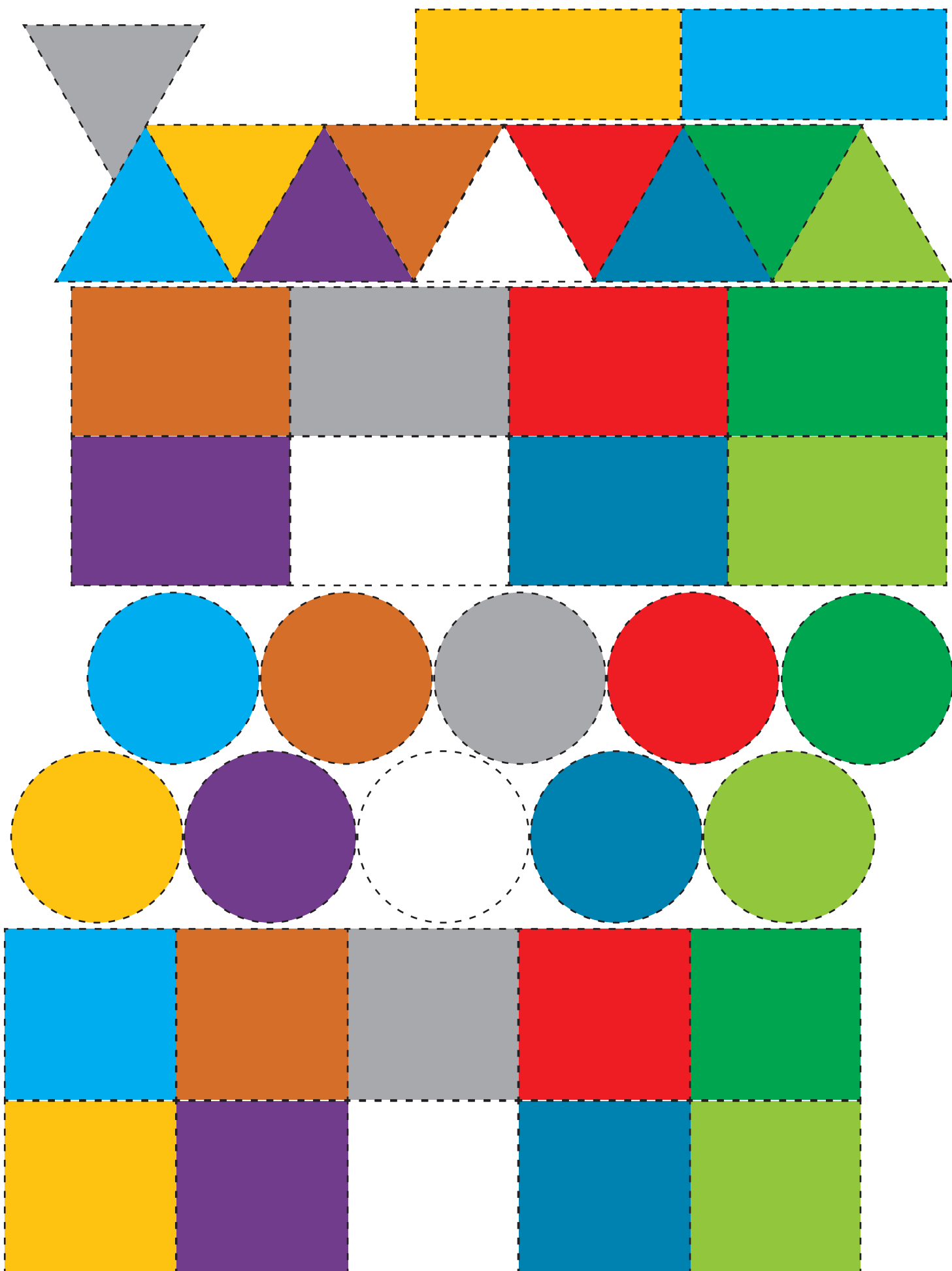

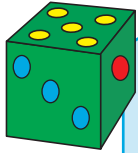

Make a dice:

Cut the dice out on the black outer line and fold on the white dotted lines. Glue the flaps to the inside of the dice.

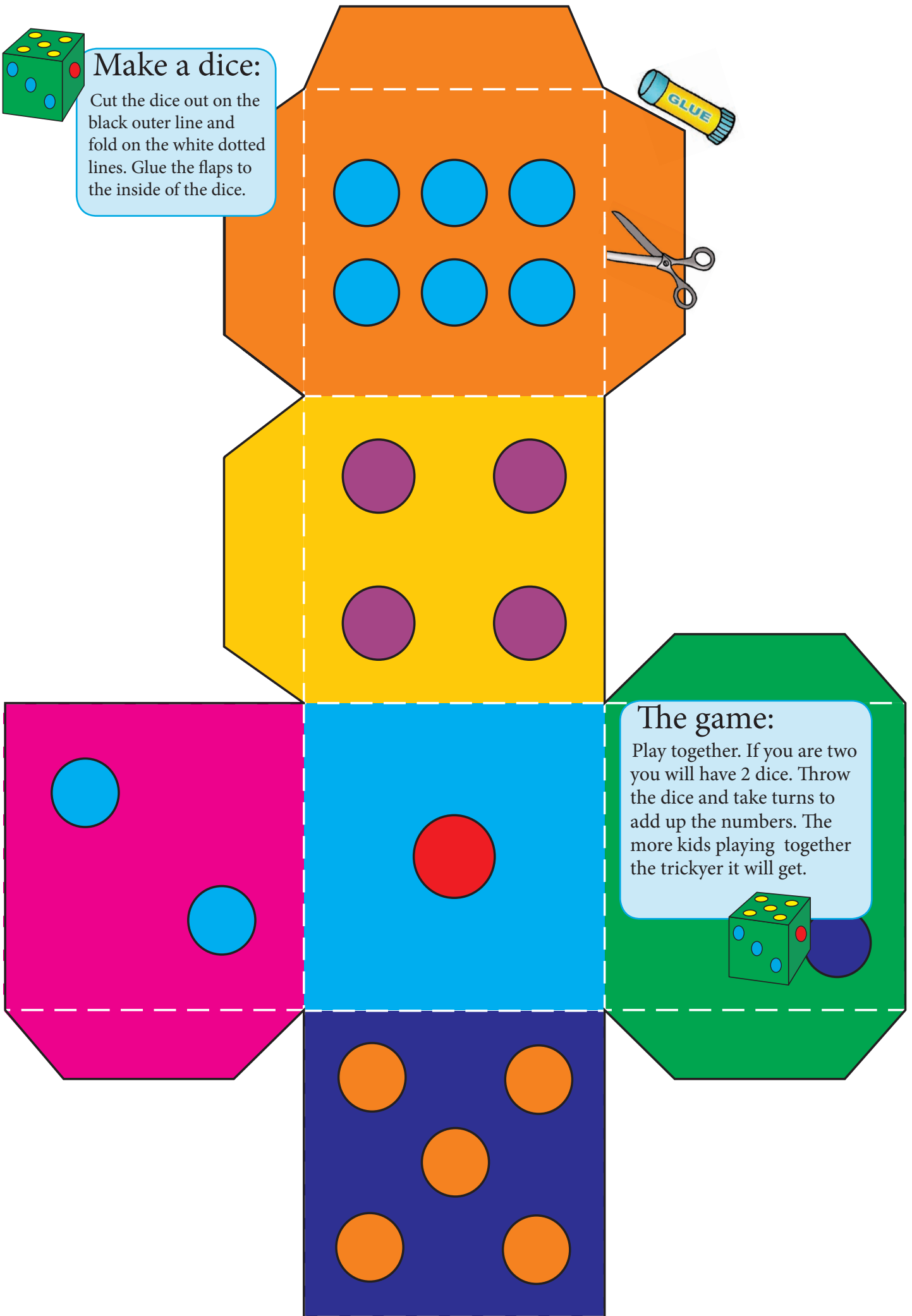

The game:

Play together. If you are two you will have 2 dice. Throw the dice and take turns to add up the numbers. The more kids playing together the trickier it will get.

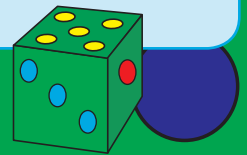

Use these cut outs numbers to complete the number board.



20	40
10	60
90	80
50	30
100	70