



Education

KwaZulu-Natal Department of Education

**NATIONAL
SENIOR CERTIFICATE**

GRADE 12

LIFE SCIENCES P1

PREPARATORY EXAMINATION

SEPTEMBER 2018

MARKS: 150

TIME: 2 1/2 hours

N.B. This question paper consists of 14 pages.

INSTRUCTIONS AND INFORMATION

Read the following instructions carefully before answering the questions.

1. Answer ALL the questions.
2. Write ALL the answers in the ANSWER BOOK.
3. Start the answers to each question at the top of a NEW page.
4. Number the answers correctly according to the numbering system used in this question paper.
5. Present your answers according to the instructions of each question.
6. Do ALL drawings in pencil and label them in blue or black ink.
7. Draw diagrams or flow charts only when asked to do so.
8. The diagrams in this question paper are NOT necessarily drawn to scale.
9. Do NOT use graph paper.
10. You must use a non-programmable calculator, a protractor and a compass where necessary.
11. Write neatly and legibly.

SECTION A**QUESTION 1**

1.1 Various options are given as possible answers to the following questions. Choose the correct answer and write only the letter (A - D) next to the question number (1.1.1 - 1.1.10) in the ANSWER BOOK, for example 1.1.11 D.

1.1.1 Which ONE of the following is true of oogenesis?

- A Occurs by mitosis only
- B The chromosome number does not change
- C Of the four cells formed, only one becomes the ovum
- D Occurs under the influence of testosterone

1.1.2 What is the name of the hormone that promotes the production of follicles in the ovary?

- A ADH
- B FSH
- C LH
- D TSH

1.1.3 Study the following factors related to reproduction in males:

- (i) Absence of testosterone
- (ii) Seminal vesicles damaged
- (iii) Prostate gland not functioning
- (iv) Epididymis blocked

Which ONE of the following combinations of factors could explain the production of semen that does not contain sperm?

- A (i) and (iv) only
- B (i), (ii), (iii) and (iv)
- C (ii) and (iii) only
- D (iii) and (iv) only

1.1.4 Meiosis differs from mitosis in that in meiosis, ...

- A the nucleus divides.
- B the new cells formed are different from each other.
- C DNA replication takes place.
- D the cytoplasm divides.

1.1.5 The following events occur during a reflex action:

- (i) The effector produces a response
- (ii) A sensory receptor is stimulated
- (iii) An impulse passes along a sensory neuron
- (iv) An impulse passes along a motor neuron

Which ONE of the following represents the events of a reflex action in the CORRECT sequence?

- A (i), (ii) (iv), (iii)
- B (ii), (iii) (iv), (i)
- C (ii), (iii) (i), (iv)
- D (i), (ii), (iii), (iv)

1.1.6 Which part of the middle ear equalises pressure on either side of the tympanic membrane?

- A Oval window
- B Eustachian tube
- C Round window
- D Ossicles

1.1.7 Which ONE of the following is the normal site of fertilisation?

- A Vagina
- B Cervix
- C Fallopian tube
- D Uterus

1.1.8 A person can feel pain in his legs but cannot move his legs as a result of damage to the

- A sensory neuron only.
- B sensory neuron and motor neuron.
- C motor neuron only.
- D sensory neuron and interneuron.

QUESTIONS 1.1.9 AND 1.1.10 REFER TO THE INFORMATION BELOW.

A learner investigated the growth of lateral buds into lateral branches in bean plants.

The steps in the investigation was as follows:

- Two groups (**A** and **B**) of 20 plants each were used.
- The apical buds were removed from the plants in Group **A**.
- The apical buds of group **B** were left unchanged.
- Every two days the total length of the lateral branches was measured.
- The average length of the lateral branches was calculated for each group.

1.1.9 Which ONE of the following is MOST likely to increase the reliability of this investigation?

- A Taking measurements daily instead of every two days
- B Using 100 plants instead of 20 in each group
- C Performing the investigation during the winter months
- D Using plants with more lateral buds

1.1.10 Which ONE of the following is a possible hypothesis for this investigation?

- A The lateral branches of Group **A** will be shorter than the lateral branches in Group **B**
- B The lateral branches of Group **A** are longer than the lateral branches in Group **B**
- C There is no difference in the length of the lateral branches in group **A** and Group **B**
- D To determine the effect of the apical bud on the growth of lateral branches

(10 x 2) **(20)**

1.2 Give the **correct biological** term for each of the following descriptions. Write only the term next to the question number (1.2.1 to 1.2.8) in the ANSWER BOOK.

- 1.2.1 A gland of the digestive system that is both endocrine and exocrine
- 1.2.2 The structure in the head of the sperm that contains enzymes
- 1.2.3 A gland that produces the hormone responsible for the regulation of salt levels in the body
- 1.2.4 The receptor in the cochlea of the ear that is responsible for hearing
- 1.2.5 The blood vessel that carry nitrogenous wastes from the foetus to the mother
- 1.2.6 The gland responsible for the production of the growth hormone
- 1.2.7 A part of the retina where no photoreceptors are found
- 1.2.8 A hormone that controls the level of thyroxin in the body

(8 x 1) (8)

1.3 Indicate whether each of the statements in COLUMN I applies to **A only**, **B only**, **both A and B** or **none** of the items in COLUMN II. Write **A only**, **B only**, **both A and B** or **none** next to the question number (1.3.1 - 1.3.3) in the ANSWER BOOK.

COLUMN I	COLUMN II
1.3.1 Eye defect caused by an uneven cornea	A: Astigmatism B: Cataract
1.3.2 The passage for menstrual flow and birth of a baby	A: Vagina B: Fallopian tube
1.3.3 Greenhouse gas	A: Methane B: Carbon dioxide

(3 x 2) (6)

1.4 The diagram below shows a certain species of fish mating.

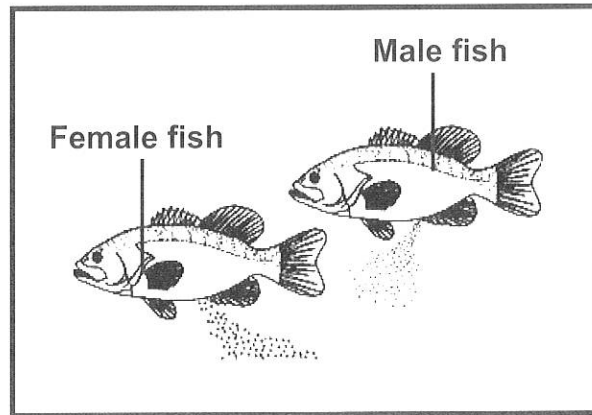

- 1.4.1 Identify the type of fertilization displayed by the fish species. (1)
 - 1.4.2 State TWO visible ways in which the chances of fertilisation in these fish are increased. (2)
 - 1.4.3 Name the reproductive strategy used by these fish that involves the production of eggs. (1)
 - 1.4.4 Give TWO reasons why there is no need for the eggs of these fish to be covered by a hard or leathery shell. (2)
- (6)**

1.5 The diagram below shows the structure of a human eye.

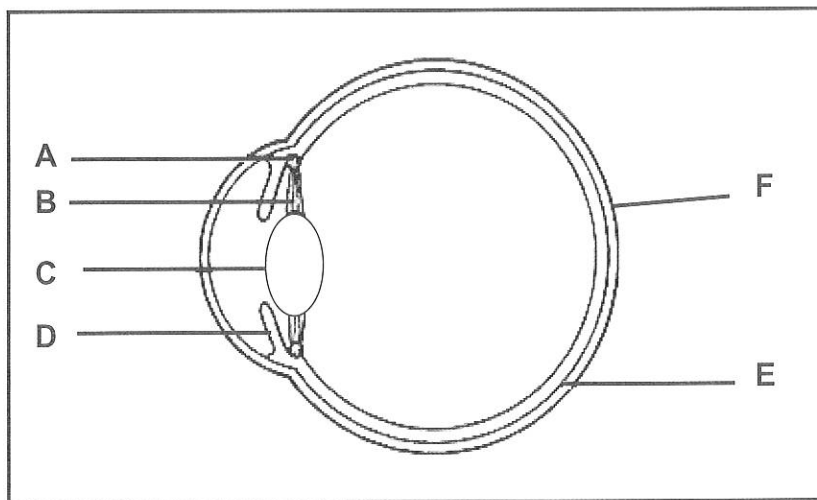

Give the LETTER and the NAME of the part which:

- 1.5.1 Prevents internal reflection of light in the eye (2)
 - 1.5.2 Contracts for near vision (2)
 - 1.5.3 Focuses light onto the retina (2)
 - 1.5.4 Becomes slack when one reads a book (2)
 - 1.5.5 Controls the amount of light entering the eye (2)
- (10)**

TOTAL SECTION A: 50

SECTION B**QUESTION 2**

- 2.1 Many seeds store starch, which is converted to glucose by enzymes when germination commences. The production of these enzymes is triggered by gibberellins, synthesized by the developing embryo.

The graph below shows the change in the concentration of gibberellins over time once germination begins.

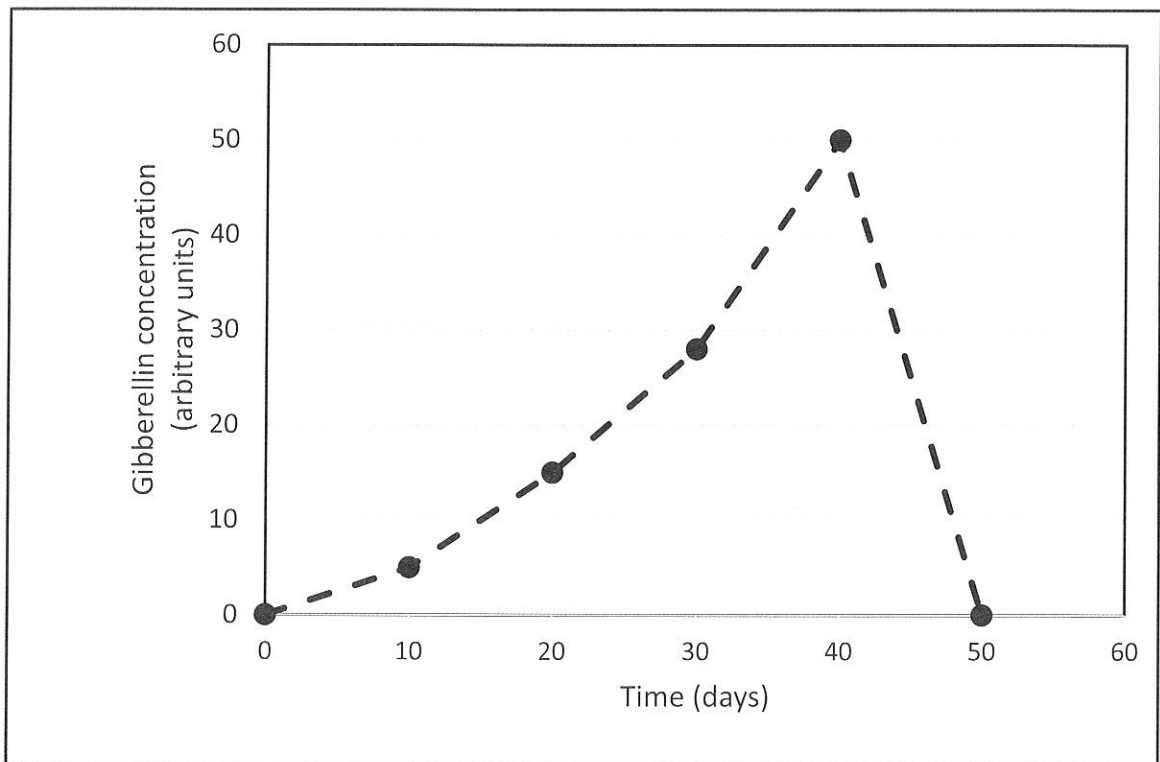

- 2.1.1 State TWO functions of gibberellins other than its role in germination. (2)
- 2.1.2 On which day was the concentration of gibberellins the highest? (1)
- 2.1.3 Explain the trend shown in the graph over the 50-day period. (4)
(7)

2.2 Study the diagram below of the human brain.

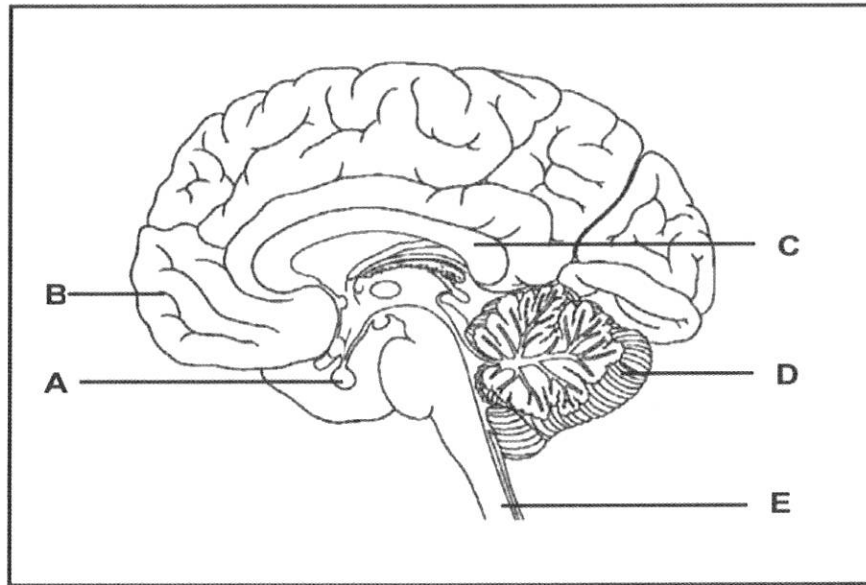

2.2.1 Write the LETTER only of the part that:

- (a) Interprets sound impulses (1)
- (b) Connects the two hemispheres of the brain (1)
- (c) Produces prolactin (1)

2.2.2 Explain ONE effect of damage to:

- (a) Structure **D** (2)
- (b) Structure **E** (2)

2.2.3 Impulses are transmitted between the brain and the rest of the body by neurons.

- (a) Explain ONE way in which the axon of a neuron is structurally suited to perform its function. (2)
 - (b) Draw a fully labelled diagram of a motor neuron. (5)
- (14)**

2.3 The diagram below represents the changes that occur in the ovary during the menstrual cycle.

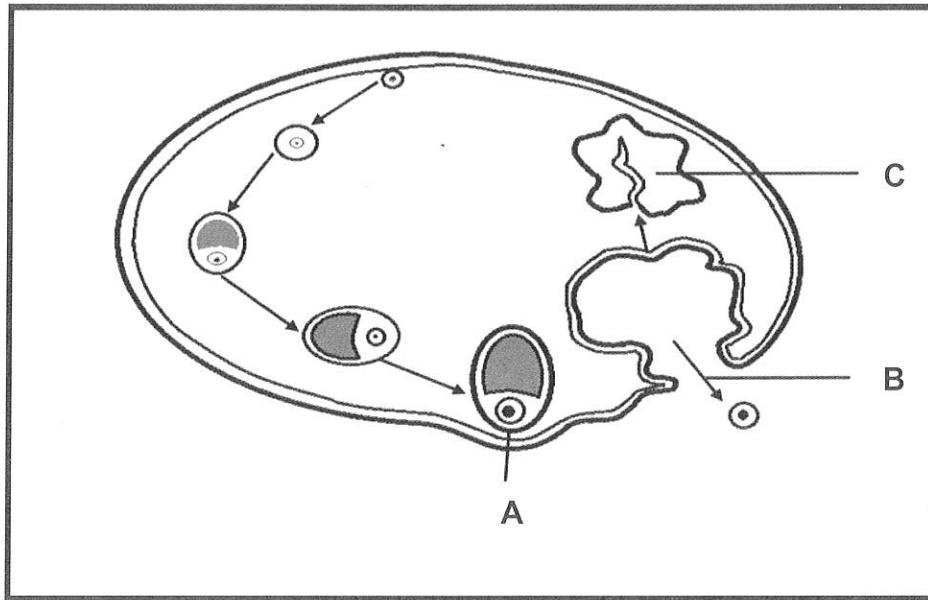

2.3.1 Identify:

(a) Process **B** (1)

(b) The hormone responsible for the development of **C** (1)

(c) The hormone produced by **A** (1)

2.3.2 Describe the effect on the menstrual cycle if structure **C** did not form. (5)

2.3.3 Describe the development of the zygote until a foetus is formed. (6)

2.3.4 List THREE functions of the amniotic fluid. (3)

2.3.5 Identify TWO systems of the baby's body whose role is performed by the placenta during gestation. (2)
(19)

[40]

QUESTION 3

3.1 Study the diagram showing the human karyotype.

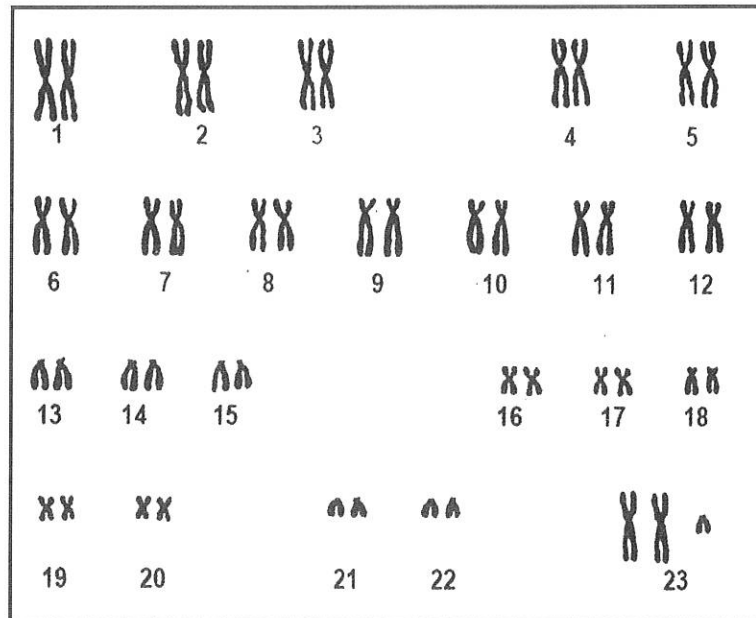

- 3.1.1 What collective name is given to the pairs of chromosomes 1 to 22? (1)
- 3.1.2 Write down the NUMBER only of the set of chromosomes indicating an abnormality. (1)
- 3.1.3 Explain how the abnormality referred to in Question 3.1.2 would have occurred through meiosis. (4)
- 3.1.4 Explain why chromosomes normally appear in pairs in a karyotype. (2)
- 3.1.5 Name the process that resulted in all chromosomes appearing double stranded. (1)
- (9)**

3.2 Read the extract below.

CONCERN OVER GENETICALLY MODIFIED (GM) MAIZE

The multinational biotechnology company, Monsanto applied to sell seeds for GM maize in South Africa.

The new gene that they inserted into the maize makes the plants less dependent on water. The plants are also more resistant to worm pests as well as the herbicide, glyphosate.

Glyphosate is used to kill unwanted weeds when GM maize is grown but it may also kill insects, including bees.

There is also concern over having MONSANTO as the only supplier of all seeds for GM maize in South Africa.

- 3.2.1 Explain ONE significance to farmers of having maize plants that are resistant to worm pests. (2)
- 3.2.2 Explain how:
- (a) The killing of bees could influence food security (4)
 - (b) The use of glyphosate could influence biodiversity (3)
- 3.2.3 Explain the economic effect on the consumer if there is only one supplier of seeds for GM maize. (2)
- 3.2.4 State the importance, for South Africa, of being able to grow crops that are less dependent on water. (2)
- (13)**

- 3.3 Deforestation has an impact on global warming.
- 3.3.1 Describe how deforestation contributes to a high carbon dioxide concentration in the atmosphere. (3)
- 3.3.2 State ONE other impact of deforestation on the environment. (1)
- 3.3.3 Differentiate between the *greenhouse effect* and *global warming*. (4)
- 3.3.4 Trees are normally planted to offset carbon emissions.
Give TWO reasons why it would be better to plant indigenous trees rather than exotic trees. (2)
- (10)**

- 3.4 An oral glucose tolerance test is used to determine if a person is diabetic.
After a period of fasting (no food intake) the person drinks a glucose solution. The person's blood glucose levels are then measured at regular intervals.
If the person's blood glucose level is above 200mg/100ml two hours after drinking the glucose solution then the patient is diagnosed as being diabetic.
The results of a glucose tolerance test performed on three different patients (1, 2 and 3) is provided in the table below.

Time (minutes)	Blood glucose levels (mg/100ml)		
	Patient 1	Patient 2	Patient 3
0(glucose solution is ingested)	85	130	100
30	125	215	210
60	100	250	180
90	85	260	170
120	80	240	160

- 3.4.1 Identify the dependent variable in this investigation. (1)
- 3.4.2 Identify TWO factors that should be kept constant in this investigation. (2)
- 3.4.3 Explain why patients 1 and 3 were NOT diagnosed as diabetics. (2)
- 3.4.4 The normal blood glucose level in the blood is 90mg/100ml.
Explain how the blood glucose levels in the blood of patient 1 will be regulated over the next 30 minutes following the investigation. (3)
- (8)**

TOTAL SECTION B: 80

SECTION C**QUESTION 4**

A girl takes part in the Comrades Marathon which is a long-distance race that starts very early on a winter's morning.

Describe the effect of adrenalin on her body and how her body temperature was regulated as she waited to start the race. Also describe the changes that took place in her eyes as the sun was rising.

Content: (17)
Synthesis: (3)

NOTE: NO marks will be awarded for answers in the form of tables, flow charts or diagrams.

TOTAL SECTION C: 20
GRAND TOTAL: 150

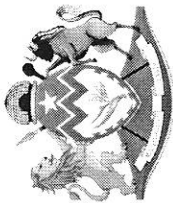

Basic Education

KwaZulu-Natal Department of Basic Education
REPUBLIC OF SOUTH AFRICA

LIFE SCIENCES P1

FINAL MEMORANDUM

PREPARATORY EXAMINATION

SEPTEMBER 2018

**NATIONAL
SENIOR CERTIFICATE**

GRADE 12

This memorandum consists of 8 pages

PRINCIPLES RELATED TO MARKING LIFE SCIENCES 2018

- If more information than marks allocated is given**
Stop marking when maximum marks is reached and put a wavy line and 'max' in the right-hand margin.
- If, for example, three reasons are required and five are given**
Mark the first three irrespective of whether all or some are correct/incorrect.
- If whole process is given when only part of it is required**
Read all and credit relevant part.
- If comparisons are asked for and descriptions are given**
Accept if differences / similarities are clear.
- If tabulation is required but paragraphs are given**
Candidates will lose marks for not tabulating.
- If diagrams are given with annotations when descriptions are required**
Candidates will lose marks
- If flow charts are given instead of descriptions**
Candidates will lose marks.
- If sequence is muddled and links do not make sense**
Where sequence and links are correct, credit. Where sequence and links is incorrect, do not credit. If sequence and links becomes correct again, resume credit.
- Non-recognised abbreviations**
Accept if first defined in answer. If not defined, do not credit the unrecognized abbreviation but credit the rest of answer if correct.
- Wrong numbering**
If answer fits into the correct sequence of questions but the wrong number is given, it is acceptable.
- If language used changes the intended meaning**
Do not accept.
- Spelling errors**
If recognizable accept provided it does not mean something else in Life Sciences or if it is out of context.
- If common names given in terminology**
Accept provided it was accepted at the National memo discussion meeting.
- If only letter is asked for and only name is given (and vice versa)**
No credit
- If units are not given in measurements**
Candidates will lose marks. Memorandum will allocate marks for units separately
- Be sensitive to the sense of an answer, which may be stated in a different way.**
- Caption**
All illustrations (diagrams, graphs, tables, etc.) must have a caption
- Code-switching of official languages (terms and concepts)**
A single word or two that appears in any official language other than the learners' assessment language used to the greatest extent in his/her answers should be credited, if it is correct. A marker that is proficient in the relevant official language should be consulted. This is applicable to all official languages.

SECTION A**QUESTION 1**

- 1.1 1.1.1 C ✓✓
 1.1.2 B ✓✓
 1.1.3 A ✓✓
 1.1.4 B ✓✓
 1.1.5 B ✓✓
 1.1.6 B ✓✓
 1.1.7 C ✓✓
 1.1.8 C ✓✓
 1.1.9 B ✓✓
 1.1.10 A ✓✓
 (10 x 2) (20)
- 1.2 1.2.1 Pancreas✓
 1.2.2 Acrosome✓
 1.2.3 Adrenal✓ gland
 1.2.4 Organ of Corti✓
 1.2.5 Umbilical artery✓
 1.2.6 Pituitary✓/hypophysis
 1.2.7 Blind spot✓
 1.2.8 Thyroid stimulating hormone✓/TSH
 (8)
- 1.3 1.3.1 A only✓✓
 1.3.2 A only✓✓
 1.3.3 Both A and B✓✓
 (3 x 2) (6)
- 1.4 1.4.1 External✓ fertilization (1)
 1.4.2 - A large amount of sperm are released✓
 - A large amount of eggs are released✓
 - The male and female swim close to each other✓/the sperm is released close to the eggs (Any 2) (2)
 (Mark first TWO only)
- 1.4.3 Ovipary✓ (1)
 1.4.4 - No danger of drying out✓
 - Water provides support✓ (2)
 (Mark first TWO only) (6)
- 1.5 1.5.1 E✓ Choroid✓ (2)
 1.5.2 A✓ Ciliary muscles✓ (2)
 1.5.3 C✓ Lens✓ (2)
 1.5.4 B✓ Suspensory ligaments✓ (2)
 1.5.5 D✓ Iris✓ (2)
 (10)

TOTAL SECTION A: 50**SECTION B****QUESTION 2**

- 2.1 2.1.1 - Elongation of internodes✓
 - Stimulates root growth✓
 - Promote development of flowers✓
 - Sprouting of dormant buds✓
 - Increases fruit size✓ (Any 2) (2)
 (Mark first TWO only)
- 2.1.2 Day 39✓/40/41 (1)
- 2.1.3 - Gibberellin concentration increases✓
 - to convert starch into glucose✓/to provide glucose for germination
 - After day 40 the hormone concentration decreases✓
 - since the germination process is over✓/the plant started photosynthesising/all the stored starch had been converted to glucose (4)
 (7)
- 2.2 2.2.1 (a) B✓ (1)
 (b) C✓ (1)
 (c) A✓ (1)
- 2.2.2 (a) - No balance✓
 - since no impulses received from receptors (cristae/maculae) ✓ /no impulses sent to the muscle/effector
 OR
 - No co-ordination of movement✓
 - since impulses cannot be sent to the muscles✓ (2)
 (Mark first ONE only)
- (b) - Reflex actions will not take place✓
 - hence subjecting the body to harm✓
 OR
 - No impulses to/from the brain✓
 - Therefore cannot interpret stimuli from some sense organs✓/cannot move voluntarily/person will be paralysed (2)
 (Mark first ONE only)

2.2.3

- (a) - Axon is long✓
- to transmit impulses over long distances✓
- OR**
- Terminal endings✓/nerve endings
- transmit impulses to next neuron✓/release neurotransmitters (2)

(Mark first ONE only)

(b)

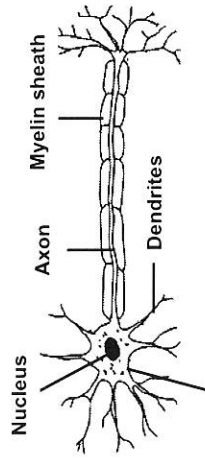

Cell body

Motor neuron drawn✓
Any 4 correct labels✓✓✓✓

2.3 2.3.1

- (a) Ovulation✓
- (b) LH✓
- (c) Oestrogen✓

(5)
(14)

2.3.2

- Level of progesterone remains low✓
- so the endometrium will no longer be maintained✓
- leading to menstruation✓
- In addition, FSH secretion is no longer inhibited✓/FSH secretion resumes
- and a new follicle starts to develop✓

(5)

2.3.3

- Zygote undergoes mitosis✓
- to form a solid ball of cells✓
- called the morula✓
- Which is then converted into a hollow ball of cells✓
- called the blastula✓
- The cells then differentiate to form the embryo✓
- with the chorion✓
- which forms the placenta✓ with the endometrium
- and the amnion✓

(Any 6) (6)

2.3.4

- Prevents the foetus from drying out✓
- Allows for easy foetal movement✓
- It acts as a shock absorber✓/prevents mechanical injury
- Keeps the foetus within a small temperature range✓
- Helps in birth process✓

(Any 3) (3)

(Mark first THREE only)

2.3.5

- Gas exchange system✓
- Digestive system✓
- Excretory system✓

(Any 2) (2)

(19)
[40]

QUESTION 3

3.1

3.1.1

Autosomes✓

(1)

3.1.2

23✓

(1)

3.1.3

- During anaphase✓/III
- The sex chromosomes/gonosomes/23rd pair of chromosomes failed to separate✓/non-disjunction
- At the end of meiosis some of the gametes contained 2 sex chromosomes✓/two chromosomes at position 23
- Fertilisation with a normal gamete/gamete with one sex chromosome occurred✓
- It resulted in a zygote with three sex chromosomes✓/three chromosomes at position 23 (Any 4) (4)

3.1.4

- They are homologous✓
- where one chromosome is maternal and one paternal✓

(2)

3.1.5

DNA replication✓

(1)

(9)

3.2

3.2.1

- Plants will not be killed by worms✓
- leading to a higher yield✓/more profit
- OR**
- Less pesticides are required✓
- allowing for a greater profit✓

(Mark first ONE only)

(2)

3.2.2 (a)

- There is going to be less pollination✓
- leading to a smaller yield✓
- leading to higher food prices✓
- People cannot afford to buy the food✓/less food available
- leading to food insecurity✓ (Any 4) (4)

(b)

- Insects are killed ✓
- Other organisms feeding on the insects also die✓
- causing a decrease in biodiversity✓ (3)

- 3.2.3 - If there is no competition in the market✓/producer can sell at any price/can only buy from one supplier (2)
 - making the food more expensive✓
- 3.2.4 - South Africa is a drought stricken/dry country✓ (2)
 - which needs crops which can survive droughts✓ (13)
- 3.3 3.3.1 - Less trees/plants ✓ (2)
 - to photosynthesise✓ (13)
 - and hence less CO₂ absorbed out of the atmosphere✓ (3)
- 3.3.2 - Lower rainfall✓
 - Soil erosion✓
 - Habitat destruction✓
 - Decreasing biodiversity✓ (Any 1) (1)
(Mark first ONE only)
- 3.3.3 Greenhouse effect
 - The trapping of heat✓
 - by the atmosphere✓
 Global warming
 - The increase in the temperature of the atmosphere✓
 - caused by the greenhouse effect✓/trapping of heat by greenhouse gases/CO₂ in the atmosphere (4)
- 3.3.4 - Indigenous trees use less water✓
 - It maintains biodiversity✓/creates habitat for indigenous animals (2)
(10)
- 3.4 3.4.1 Blood glucose level✓ (1)
 3.4.2 - Mass of the patients✓
 - Age of patients✓
 - Gender of patients✓
 - Length of fasting✓
 - Amount of glucose solution given to patients✓
 - Person conducting the measurement✓
 - Time of measurement for all patients✓
 - Instrument used for measuring glucose level✓ (Any 2) (2)
(Mark first TWO only)
- 3.4.3 Their glucose level went below 200mg/100ml before 2 hours✓✓ (2)
- 3.4.4 - The pancreas will secrete more glucagon✓
 - which will convert more glycogen into glucose✓
 - causing the glucose level to increase✓ up to 90mg/100ml (3)
(8)
[40]

TOTAL SECTION B: 80

SECTION C

QUESTION 4

Role of adrenaline

- The liver✓/muscles
- converts glycogen to glucose✓
- Rate/depth of breathing increases✓
- Heartbeat increases✓
- Blood flow to unessential organs decreases✓
- allowing greater blood flow to the muscles✓/brain/heart
- bringing in more oxygen and glucose✓
- making more energy available✓
- Muscle tone increases✓

(Any 7) (7)

Temperature regulation

- Hypothalamus is stimulated✓
- and impulses are sent to the blood vessels✓
- The blood vessels of the skin constrict✓/vasoconstriction occurs
- Less blood flows to the surface of the skin✓
- Less heat is lost from the skin✓
- Less blood is also sent to the sweat glands✓
- Less sweat is released✓
- and hence less cooling occurs✓
- maintaining a constant body temperature✓

(Any 6) (6)

Pupillary mechanism

- The iris✓ of the eye responds
- The circular muscles contract✓
- The radial muscles relax✓
- The pupil constricts✓
- decrease the amount of light entering the eye✓

(Any 4) (4)
(17)

ASSESSING THE PRESENTATION OF THE ESSAY

Relevance (R)	Logical sequence (L)	Comprehension (C)
All information given is relevant to: - Role of Adrenalin - Temperature regulation - Pupillary mechanism There is no irrelevant information	Ideas are put in a logical sequence in each of the following: - Role of Adrenalin - Temperature regulation - Pupillary mechanism	Answered all aspects: - Role of Adrenalin (5/7) - Temperature regulation (4/6) - Pupillary mechanism (2/4)

Synthesis (3)

(20)

TOTAL SECTION C: 40

GRAND TOTAL: 150